

Industrial Forged Fittings and Accessories

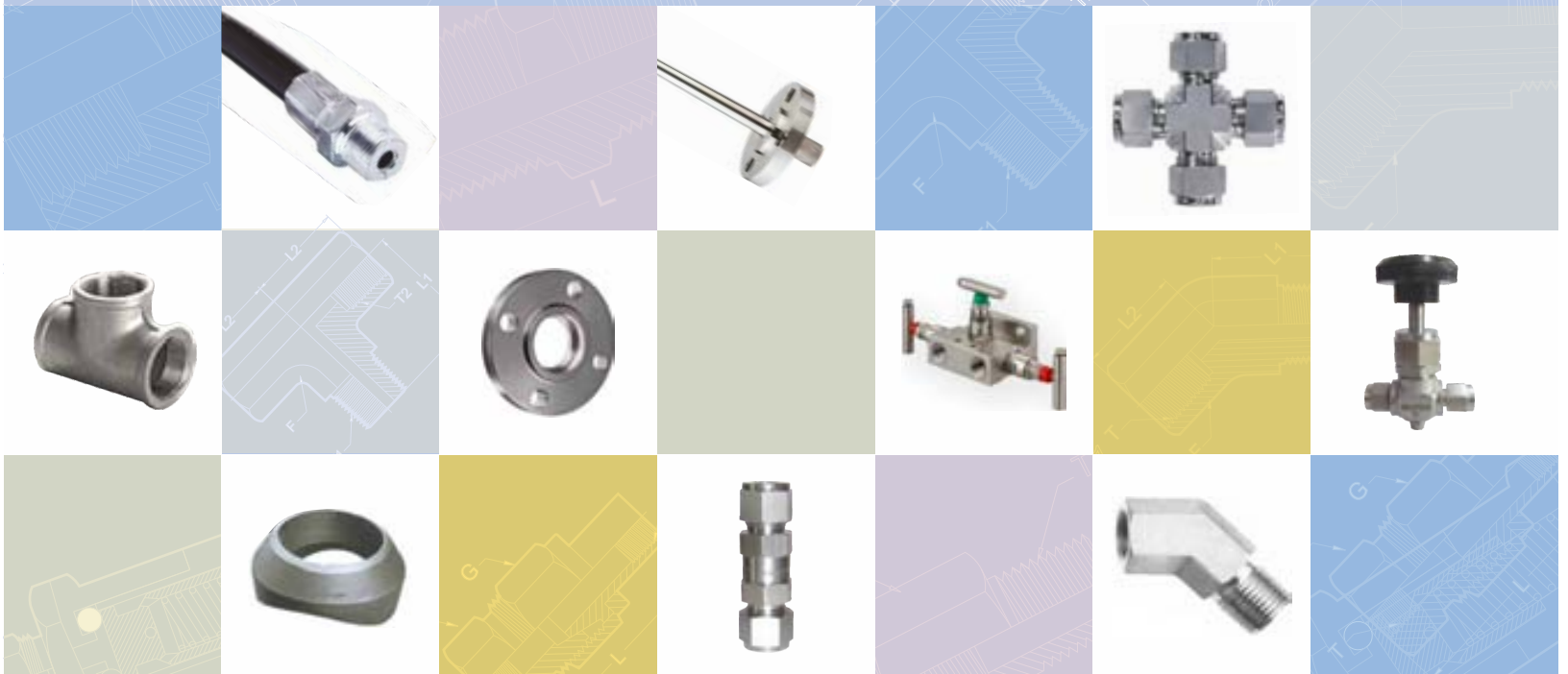

- DOUBLE COMPRESSION TUBE FITTINGS
- NEEDLE VALVES
- VALVE MANIFOLDS
- THERMOWELLS
- FLANGES
- QUICK RELEASE COUPLING
- FORGED BRANCHOLET FITTINGS
- HIGH PRESSURE FORGED FITTINGS
- PLUGS AND BUSHINGS
- THREADED FITTINGS
- ACCESSORIES

We deliver the best



Spraytech Systems (India) Pvt. Ltd. is worlds leading organization in engineering and manufacturing of Industrial Spray Nozzle, Systems, Tube fittings, Pipe fittings, Instrumentation fittings, all kind of Hydraulic valves and Manifolds.



With the experiences of decades in this field and team of skilled engineers we have developed a strong foundation among all over the world.

Spraytech having three plants, headquarter at Wagle Industrial estate, Thane. second at Indapur, Pune and third one at Rabale, Navi Mumbai. All plants are equipped with next generation class CNC machines, heavy material handling equipments to serve raising market demands with no compromise with world class product quality along with this field of engineering we have entered in forging to serve respective product demands.



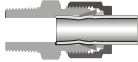

INDEX

DOUBLE COMPRESSION TUBE FITTINGS		1
CHECK VALVES		20
NEEDLE VALVES		21
VALVE MANIFOLDS		21
THERMOWELLS		22
FLANGES		22
QUICK RELEASE COUPLING		23
FORGED BRANCHOLET FITTINGS		24
HIGH PRESSURE FORGED FITTINGS		25
PLUGS AND BUSHINGS		26
ACCESSORIES		28
INSTRUMENT TUBING MATERIAL SELECTION GUIDE		28
CONVERSION DATA		29





DOUBLE COMPRESSION TUBE FITTINGS

Design & Function

Double compression (Double ferrule) tube fittings provide a leak proof, torque free joints in all instrumentation & process tubing connections which will withstand high pressure, Impulse, Vacuum, Vibration and temperature. These features eliminates costly, hazardous leaks and provide highest safety and maintenance free tubing joints.

All action in the fittings move axially, i.e. Tube is not twisted during assembly. Since no torque is transmitted from the fittings to the tubing, there is no initial strain, which might weaken the tubing. Each part in the fitting assembly is machined to most exact dimensional tolerance on CNC machines. Total quality management is practiced throughout the manufacturing process as per ISO standard to achieve best quality joints at all tubing end connections. Tube fitting assembly consist of four precision machined components namely body, nut, front ferrule and back ferrule. All you need to do is to insert the tube and tighten the nut by 1 ¼ turn from finger tight position. This action forces both front & back ferrule to move forward between nut and body, Back ferrule is driven against the rear taper of the front ferrule and swaged radially inward on the tube & thus holding the tube against vibration and mechanical pull due to pressure. Back ferrule also lift the front ferrule out to form a full faced seal on the taper surface of the body. Front ferrule also moves forward against the taper portion of the fitting body and due to wedging action forces inward, gripping and subsequently sealing the front edge tightly on to the tubing.

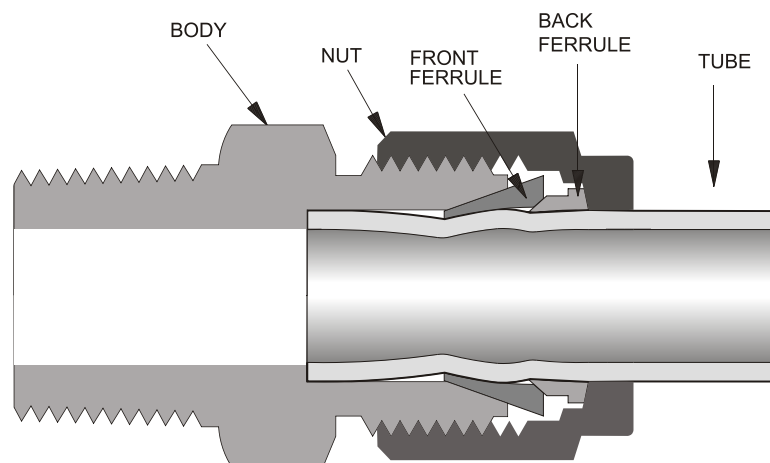

Design Features

Double ferrule fitting consists of 4 parts for leak proof maintenance free joints.

- Back ferrule dampens the tube circuit mechanical vibration through spring like action, also prevent carry over tightening torque from nut to front ferrule.
- The front ferrule circumferentially seals the surface between tube and the fitting body. The front edge of the ferrule is pressed on to the tube so that pressure tight impression is formed.
- The nut is silver plated to avoid galling and give low assembly torque.
- No Pre-Lubrication needed, also allows repeated make and remake.

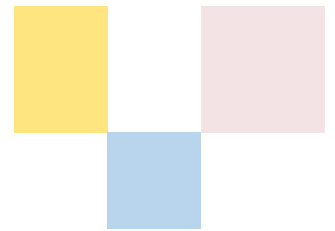

Other Features

- Flare less design.
- Available for metric and fractional (imperial inch size) tubes with choice of NPT/BSPT/BSP/SAE/ISO pipe threads.
- Wide range of sizes and configurations.
- Manufacture in wide range of material like Stainless Steel, Steel, Brass, Aluminum, Titanium, Hastalloy, Monel and other special alloys.
- All components of fittings are made of same material.
- Excellent make and remake life.
- Interchangeable with leading international brands.

Material Specifications And Standard

Material	Barstock	Forgings	Designator
SS316/316L	ASTMA276 ASMESA479	ASTMA182 ASMESA182	316/316L
CarbonSteel	ASTMA105	ASTMA105	CS
Aluminum	ASTMB211	ASTMB247	AL
Alloy400(Monel)	ASTMB164 ASMESB164	ASTMB564 ASMESB564	M
Alloy600	ASTMB166 ASMESB166	ASTMB564 ASMESB564	A600
Alloy20	ASTMB473	ASTMB462	A20
AlloyC276 (Hastalloy)	ASTMB574	ASTMB564	H
Titanium	ASTMB348	ASTMB381	TI
Brass	ASTMB16 ASTMB453	ASTMB283	B

Identification of Fractional and Metric Tube Fittings

As there is marginal difference in nearest metric and fractional size of tubes, visually it is difficult to identify fitting tube sizes. Therefore step is provided on both body and nut for metric tube fittings as shown in following illustration.

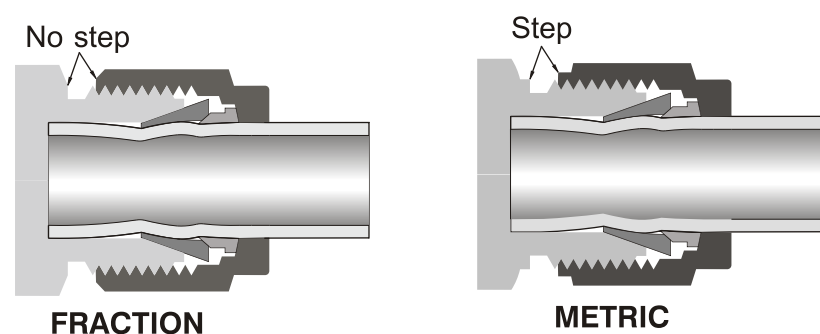

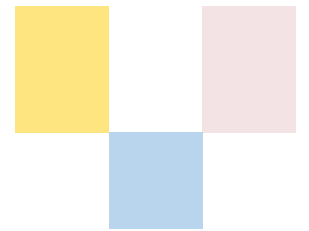

Product Coding System

Following example will show how to prepare product code.

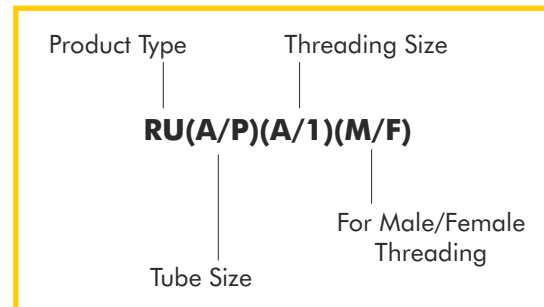

1) Product Type

RU - Reducing Union
UN - Union
BU - Bulkhead Union etc.

2) Tube Size

INCHES	METRIC
A - 1/8"	P - 3mm
B - 3/16"	Q - 6mm
C - 1/4"	R - 8mm
E - 5/16"	T - 10mm
F - 3/8"	U - 12mm
G - 1/2"	V - 16mm
H - 5/8"	W - 20mm
J - 3/4"	X - 25mm
K - 7/8"	
L - 1"	

3) Threading Size

INCHES	SAE
A - 1/8"	1 = 7/16-20
B - 3/16"	2 = 9/16-18
C - 1/4"	3 = 5/16-24
E - 5/16"	4 = 3/4-16
F - 3/8"	5 = 7/8-14
G - 1/2"	6 = 1/2-20
H - 5/8"	7 = 1-1/16-12
J - 3/4"	8 = 1-5/16-12
K - 7/8"	9 = 1-3/16-12
L - 1"	

STEP1



STEP2



STEP3

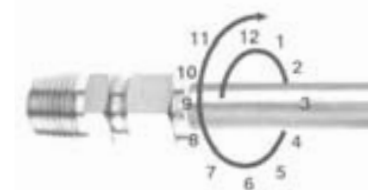

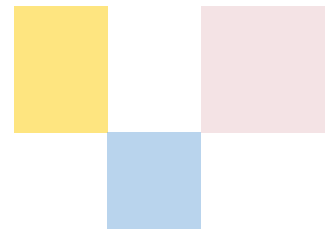

Safety Precautions

- Do not mix up parts from different manufacturers
- Select proper tube thickness as per working pressure requirement (refer table)
- Usefully annealed tube (preferred hardness 70-75RB), free from scratches, surface defects
- While assembling always hold the body firmly and rotate the nut, do not turn the body
- Use proper thread sealant while assembling taper threads
- While installing fitting near tube bends, leave sufficient straight length to allow tube to be bottomed the fitting
- While tightening or loosening a fitting be sure that the system is not pressurized
- Do not loosen the nut or pipe thread to bleed the system line

Pipe Thread Specification

THREADTYPE	NPT	ISOP/BSP	ISOT/BSPT	SAE
REFERENCE	ASME1.20.1	ISO228,B S2779,	JISB0202	ASMEB1.1
SPECIFICATION	SAEAS71051	ISO7,Bs21	JISB0203	

Pressure Rating and Tubing Selection

Double and single compression SS Tube fittings are rated to the maximum working pressure of the tubing gas shown below. Therefore proper selection of tubing must be done while making safe leak free joint. Tube should be fully annealed, high quality stainless steel tubing. The preferred hardness is Rb70 or less. The tubing should be free from scratches, surface defects and suitable for bending.

Following rating is based on annealed seamless 304 or 316 SS tubing with ultimate tensile strength 517000 kPa and allowable working pressure load of 137800 kPa.

Seamless tube wall thickness (SWG/Inch)

	Tube OD.	22 0.028	20 0.035	18 0.049	16 0.064	14 0.083	12 0.104
Maximum Working Pressure inPSI	1/4"	4000	5000	7500	10200		
	5/16"		4000	5800	8000		
	3/8"		3300	4800	6500		
	1/2"		2400	3500	4700	6200	
	5/8"			2900	4000	5200	6000
	3/4"			2400	3300	4200	4900
	7/8"			2000	2800	3600	4200
	1"				2400	3100	3600

NOTE : No allowance is made for corrosion or erosion, for welded tubing multiply above pressure rating by 0.80



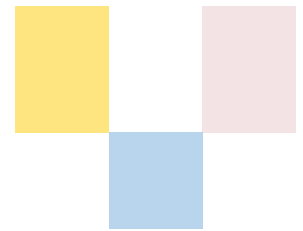

UNION

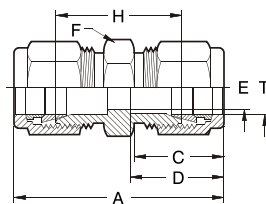

Imperial Tubing Union

PART NO	TUBE OD	A	C	D	E MIN	F A/F	G A/F	H Body
UNA	1/8"	1.41	0.61	0.51	0.10	7/16"	7/16"	0.88
UNB	3/16"	1.48	0.64	0.65	0.13	7/16"	1/2"	0.95
UNC	1/4"	1.62	0.71	0.61	0.20	1/2"	9/16"	1.03
UNE	5/16"	1.70	0.74	0.65	0.26	9/16"	5/8"	1.11
UNF	3/8"	1.78	0.77	0.67	0.29	5/8"	11/16"	1.19
UNG	1/2"	2.03	0.87	0.91	0.42	13/16"	7/8"	1.22
UNH	5/8"	2.06	0.87	0.97	0.51	15/16"	1"	1.25
UNJ	3/4"	2.12	0.87	0.97	0.63	1-1/16"	1-1/8"	1.31
UNK	7/8"	2.18	0.87	1.03	0.73	1-1/4"	1-1/4"	1.37
UNL	1"	2.56	1.05	1.24	0.89	1-3/8"	1-1/2"	1.59

Metric Tubing Um

UNP	3	35.31	15.31	12.91	2.41	11.01	11.01	22.21
UNQ	6	41.01	17.71	15.31	4.81	14.01	14.01	26.21
UNR	8	43.21	18.61	16.21	6.31	14.01	16.01	28.21
UNT	10	46.21	19.51	17.21	7.71	17.01	19.01	31.01
UNU	12	51.21	22.01	23.01	9.51	20.61	22.01	31.01
UNV	16	52.31	22.01	24.41	12.71	24.01	25.41	31.81
UNW	20	55.01	22.01	26.11	15.91	30.01	32.01	34.81
UNX	25	65.01	26.51	31.21	21.81	35.01	38.01	40.41

UNION ELBOW

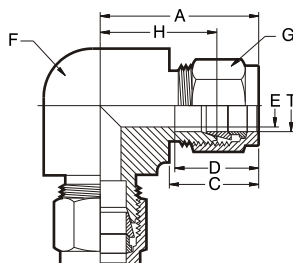

Imperial Tubing

PART NO	TUBE OD	A	C	D	E	F A/F	G A/F	H Body
UEA	1/8"	0.89	0.61	0.51	0.10	1/2"	7/16"	0.62
UEB	3/16"	1.01	0.64	0.65	0.13	1/2"	1/2"	0.74
UEC	1/4"	1.07	0.71	0.61	0.20	9/16"	9/16"	0.77
UEE	5/16"	1.14	0.74	0.65	0.26	9/16"	5/8"	0.84
UEF	3/8"	1.21	0.77	0.67	0.29	5/8"	11/16"	0.91
UEG	1/2"	1.43	0.87	0.91	0.42	13/16"	7/8"	1.02
UEH	5/8"	1.51	0.87	0.97	0.51	15/16"	1"	1.10
UEJ	3/4"	1.57	0.87	0.97	0.63	1-1/16"	1-1/8"	1.17
UEK	7/8"	1.77	0.87	1.03	0.73	1-1/4"	1-1/4"	1.36
UEL	1"	1.94	1.05	1.24	0.89	1-3/8"	1-1/2"	1.45

Metric Tubing

UEP	3	22.31	15.31	12.91	2.41	11.01	11.01	15.71
UEQ	6	27.01	17.71	15.31	4.81	15.01	14.01	19.61
UER	8	28.81	18.61	16.21	6.31	15.01	16.01	21.31
UET	10	31.51	19.51	17.21	7.91	17.01	19.01	23.91
UEU	12	36.01	22.01	23.01	9.51	20.51	22.01	25.91
UEV	16	38.01	22.01	24.61	12.71	24.01	25.41	28.01
UEW	20	44.61	22.01	26.11	15.91	32.01	32.01	34.51
UEX	25	49.01	26.51	31.21	21.81	35.01	38.11	36.81

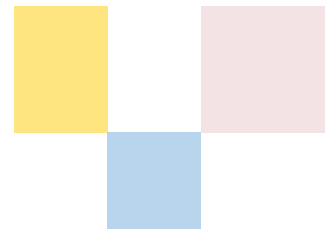

REDUCING UNION

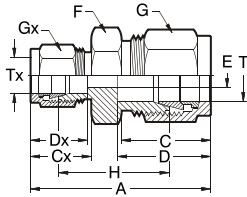

Imperial Tubing

PART NO.	TUBE OD T'	TUBE OD Tx'	A ~	C ~	Cx ~	D ~	Dx ~	E MIN	F A/F	G NUT	GX NUT	H BODY
RUCA	1/4"	1/8"	1.53	0.71	0.61	0.61	0.51	0.10	1/2"	9/16"	7/16"	0.97
RUEA	5/16"	1/4"	1.67	0.74	0.71	0.65	0.61	0.20	9/16"	5/8"	9/16"	1.08
RUFA	3/8"	1/4"	1.71	0.77	0.71	0.67	0.61	0.20	5/8"	11/16"	9/16"	1.12
RUGA	1/2"	1/4"	1.86	0.87	0.71	0.91	0.61	0.20	13/16"	7/8"	9/16"	1.16
RUGF	1/2"	3/8"	1.91	0.87	0.77	0.91	0.67	0.29	13/16"	7/8"	11/16"	1.22
RUHA	5/8"	3/8"	1.95	0.87	0.77	0.97	0.67	0.29	15/16"	1"	11/16"	1.25
RUHG	5/8"	1/2"	2.06	0.87	0.87	0.97	0.91	0.42	15/16"	1"	7/8"	1.25
RUJF	3/4"	3/8"	2.01	0.87	0.87	0.97	0.67	0.29	1-1/16"	1-1/8"	11/16"	1.31
RUJG	3/4"	1/2"	2.12	0.87	0.87	0.97	0.91	0.42	1-1/16"	1-1/8"	7/8"	1.31
RUJH	3/4"	5/8"	2.12	0.87	0.87	0.97	0.97	0.51	1-1/16"	1-1/8"	15/16"	1.31
RULJ	1"	3/4"	2.39	1.05	0.87	1.24	0.97	0.63	1-3/8"	1-1/2"	1-1/8"	1.50

Metric Tubing

RUQP	6	3	38.61	17.71	15.31	15.31	12.91	2.41	15.1	15.01	11.01	24.61
RURQ	8	6	42.31	18.61	17.71	16.21	15.31	4.81	15.1	17.01	14.01	27.41
RUTQ	10	6	44.51	19.51	17.71	17.21	15.31	4.81	18.1	20.01	14.01	29.51
RUTR	10	8	45.11	19.51	18.61	17.21	16.21	6.31	18.1	20.01	16.01	30.01
RUUQ	12	6	47.01	22.01	17.71	23.01	15.31	4.81	20.7	22.01	14.01	29.51
RUUR	12	8	47.81	22.01	18.61	23.01	16.21	6.31	20.7	22.01	16.01	30.21
RUUT	12	10	48.71	22.01	19.51	23.01	17.21	7.91	20.7	22.01	19.01	31.01
RUVT	16	10	49.51	22.01	19.51	24.61	17.21	7.91	25.1	25.41	19.01	31.81
RUVU	16	12	52.01	22.01	22.01	24.61	23.01	9.51	25.1	25.41	22.01	31.81
RUXW	25	20	62.31	26.51	22.01	31.21	26.11	15.91	36.1	38.01	32.01	39.91

BULKHEAD UNION

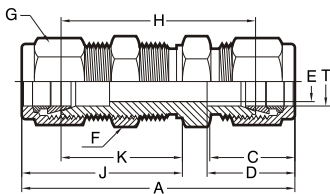

Imperial Tubing BHU

PART NO.	TUBE OD T'	A ~	C ~	D ~	E	F A/F	G A/F	H	J ~	K	Panel Hole Size
BUA	1/8"	2.03	0.61	0.51	0.10	1/2"	7/16"	1.50	1.23	0.97	0.33
BUB	3/16"	2.12	0.64	0.65	0.13	7/16"	1/2"	1.59	1.26	1.00	0.39
BUC	1/4"	2.28	0.71	0.61	0.20	5/8"	9/16"	1.69	1.32	1.03	0.45
BUE	5/16"	2.40	0.74	0.65	0.26	11/16"	5/8"	1.81	1.41	1.12	0.52
BUF	3/8"	2.46	0.77	0.67	0.29	3/4"	11/16"	1.87	1.45	1.16	0.58
BUG	1/2"	2.81	0.87	0.91	0.42	15/16"	7/8"	2.00	1.65	1.25	0.77
BUH	5/8"	2.87	0.87	0.97	0.51	1-1/16"	1"	2.06	1.68	1.28	0.89
BUJ	3/4"	3.12	0.87	0.97	0.63	1-3/16"	1-1/8"	2.31	1.87	1.47	1.02
BUL	1"	3.78	1.05	1.24	0.89	1-5/8"	1-1/2"	2.81	2.26	1.78	1.33

Metric Tubing BHUm

BUP	3	51.31	15.31	12.91	2.41	12.71	11.01	38.11	31.21	24.61	8.31
BUQ	6	57.71	17.71	15.31	4.81	16.01	14.01	42.91	33.51	26.21	11.51
BUR	8	61.01	18.61	16.21	6.31	17.41	16.01	46.01	36.11	28.61	13.11
BUT	10	63.71	19.51	17.21	7.91	19.01	17.41	48.51	37.01	29.41	16.31
BUU	12	71.01	22.01	23.01	9.51	24.01	22.01	50.81	41.91	31.81	19.51
BUV	16	72.51	22.01	24.61	12.71	27.01	25.41	52.41	42.61	32.51	22.81
BUW	20	84.51	22.01	26.11	15.91	35.01	32.01	64.31	53.01	42.91	29.01
BUX	25	95.81	26.21	31.21	21.81	41.01	38.01	71.41	57.41	45.21	33.71



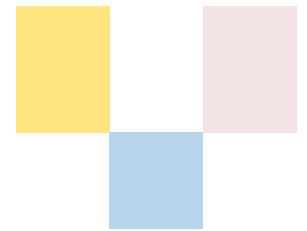

UNION TEE

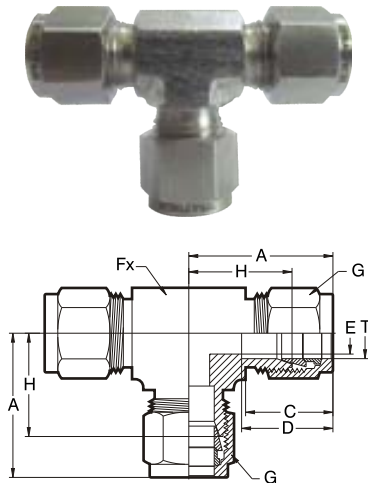

Imperial Tubing

PART NO.	TUBE OD	A	C	D	E	Fx A/F	G A/F	H BODY
UTA	1/8"	0.89	0.61	0.51	0.1	1/2"	7/16"	0.62
UTB	3/16"	1.01	0.64	0.65	0.13	1/2"	1/2"	0.70
UTC	1/4"	1.07	0.71	0.61	0.20	9/16"	9/16"	0.77
UTE	5/16"	1.18	0.74	0.65	0.26	9/16"	5/8"	0.88
UTF	3/8"	1.20	0.77	0.66	0.29	5/8"	11/16"	0.91
UTG	1/2"	1.42	0.87	0.91	0.42	13/16"	7/8"	1.02
UTH	5/8"	1.51	0.87	0.97	0.51	15/16"	1"	1.13
UTJ	3/4"	1.57	0.87	0.97	0.63	1-1/16"	1-1/8"	1.17
UTK	7/8"	1.77	0.87	1.03	0.73	1-1/4"	1-1/4"	1.36
UTL	1"	1.94	1.05	1.24	0.89	1-3/8"	1-1/2"	1.45

Metric Tubing

UTP	3	22.31	15.31	12.71	2.41	12.71	11.01	15.71
UTQ	6	27.01	17.71	15.31	4.81	12.71	14.01	19.61
UTR	8	29.71	18.61	16.21	6.31	15.01	16.01	22.21
UTT	10	31.51	19.51	17.51	7.91	17.01	19.01	23.91
UTU	12	36.01	22.01	23.01	9.51	22.01	22.01	25.91
UTV	16	38.01	22.01	24.61	12.71	24.01	25.41	28.71
UTW	20	44.61	22.01	26.11	15.91	32.01	32.01	34.51
UTX	25	49.01	26.51	21.81	21.81	35.01	38.01	36.81

UNION CROSS

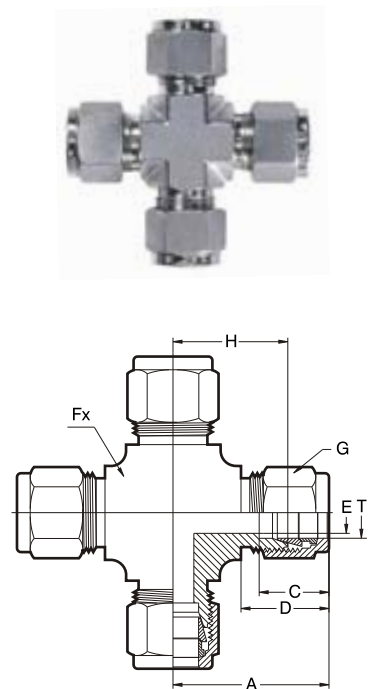

Imperial Tubing

PART NO.	TUBE OD	A	C	D	E	Fx A/F	G A/F	H BODY
UCA	1/8"	0.89	0.61	0.51	0.10	1/2"	7/16"	0.62
UCB	3/16"	1.01	0.64	0.65	0.13	1/2"	1/2"	0.70
UCC	1/4"	1.07	0.71	0.61	0.20	9/16"	9/16"	0.77
UCE	5/16"	1.18	0.74	0.65	0.26	9/16"	5/8"	0.88
UCF	3/8"	1.20	0.77	0.66	0.29	5/8"	11/16"	0.91
UCG	1/2"	1.42	0.87	0.91	0.42	13/16"	7/8"	1.02
UCH	5/8"	1.51	0.87	0.97	0.51	15/16"	1"	1.13
UCJ	3/4"	1.57	0.87	0.97	0.63	1-1/16"	1-1/8"	1.17
UCK	7/8"	1.77	0.87	1.03	0.73	1-1/4"	1-1/4"	1.36
UCL	1"	1.94	1.05	1.24	0.89	1-3/8"	1-1/2"	1.45

Metric Tubing

UCP	3	22.31	15.31	12.71	2.41	12.71	11.01	15.71
UCQ	6	27.01	17.71	15.31	4.81	12.71	14.01	19.61
UCR	8	29.71	18.61	16.21	6.31	15.01	16.01	22.21
UCT	10	31.51	19.51	17.51	7.91	17.01	19.01	23.91
UCU	12	36.01	22.01	23.01	9.51	22.01	22.01	25.91
UCV	16	38.01	22.01	24.61	12.71	24.01	25.41	28.71
UCW	20	44.61	22.01	26.11	15.91	32.01	32.01	34.51
UCX	25	49.01	26.51	21.81	21.81	35.01	38.01	36.81

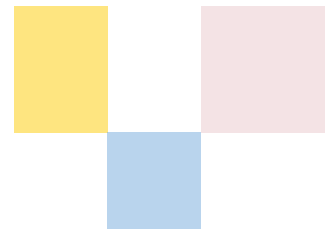

MALE CONNECTOR

Imperial Tubing										
PART NO.	'T TUBE OD.	N.P.T 'P'	A ~	B ~	C ~	D ~	E MIN	F A/F	G A/F	H BODY
MCAA	1/8"	1/8"	1.21	0.39	0.61	0.51	0.09	1/2"	7/16"	0.94
MCAC	1/8"	1/4"	1.41	0.57	0.61	0.51	0.09	9/16"	7/16"	1.14
MCBA	3/16"	1/8"	1.24	0.39	0.64	0.54	0.12	1/2"	1/2"	0.97
MCBC	3/16"	1/4"	1.44	0.57	0.64	0.54	0.12	9/16"	1/2"	1.17
MCCA	1/4"	1/8"	1.30	0.39	0.71	0.61	0.19	1/2"	9/16"	1.00
MCCC	1/4"	1/4"	1.50	0.57	0.71	0.61	0.19	9/16"	9/16"	1.20
MCCF	1/4"	3/8"	1.52	0.57	0.71	0.61	0.19	11/16"	9/16"	1.22
MCCG	1/4"	1/2"	1.77	0.76	0.71	0.61	0.19	7/8"	9/16"	1.47
MCEC	5/16"	1/4"	1.52	0.57	0.74	0.65	0.25	9/16"	5/8"	1.23
MCFA	3/8"	1/8"	1.40	0.39	0.77	0.67	0.19	5/8"	11/16"	1.10
MCFC	3/8"	1/4"	1.58	0.57	0.77	0.67	0.28	5/8"	11/16"	1.28
MCFE	3/8"	3/8"	1.58	0.57	0.77	0.67	0.28	11/16"	11/16"	1.28
MCFG	3/8"	1/2"	1.83	0.76	0.77	0.67	0.28	7/8"	11/16"	1.53
MCGC	1/2"	1/4"	1.72	0.57	0.87	0.90	0.28	13/16"	7/8"	1.31
MCGF	1/2"	3/8"	1.72	0.57	0.87	0.90	0.38	13/16"	7/8"	1.31
MCGG	1/2"	1/2"	1.94	0.76	0.87	0.90	0.41	7/8"	7/8"	1.53
MCGJ	1/2"	3/4"	2.00	0.76	0.87	0.90	0.41	1-1/16"	7/8"	1.59
MCHF	5/8"	3/8"	1.75	0.57	0.87	0.97	0.38	13/16"	1"	1.34
MCHG	5/8"	1/2"	1.94	0.76	0.87	0.97	0.47	13/16"	1"	1.53
MCJG	3/4"	1/2"	2.00	0.76	0.87	0.97	0.47	1-1/16"	1-1/8"	1.59
MCJJ	3/4"	3/4"	2.00	0.76	0.87	0.97	0.62	1-1/16"	1-1/8"	1.59
MCJL	3/4"	1"	2.26	0.95	0.87	0.97	0.62	1-3/8"	1-1/8"	1.85
MCKJ	7/8"	3/4"	2.00	0.76	0.87	1.03	0.62	1-1/4"	1-1/4"	1.59
MCLJ	1"	3/4"	2.27	0.76	1.05	1.24	0.62	1-3/8"	1-1/2"	1.78
MCLL	1"	1"	2.45	0.95	1.05	1.24	0.88	1-3/8"	1-1/2"	1.97

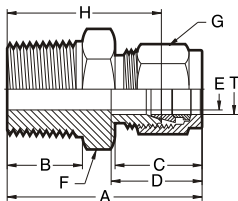

Metric Tubing										
PART NO.	TUBE OD.	N.P.T 'P'	A	B	C	D	E	F	G	H
MCPA	3	1/8"	30.51	9.71	15.31	12.91	2.41	12.71	12.71	23.91
MCPC	3	1/4"	35.61	14.21	15.31	12.91	2.41	14.01	12.71	29.01
MCQA	6	1/8"	32.81	9.71	17.71	15.31	4.81	14.01	14.01	25.41
MCQC	6	1/4"	38.01	14.21	17.71	15.31	4.81	14.01	14.01	30.51
MCQF	6	3/8"	38.41	14.21	17.71	15.31	4.81	17.01	14.01	31.01
MCQG	6	1/2"	44.71	19.01	17.71	15.31	4.81	22.01	14.01	37.31
MCRC	8	1/4"	38.71	14.21	18.61	16.21	6.31	14.01	16.01	31.41
MCRF	8	3/8"	39.21	14.21	18.61	16.21	6.31	17.01	16.01	31.81
MCRG	8	1/2"	45.61	19.01	18.61	16.21	6.31	22.01	16.01	38.11
MCTC	10	1/4"	41.01	14.21	19.51	17.21	7.11	19.01	19.01	33.31
MCTF	10	3/8"	41.01	14.21	19.51	17.21	7.91	19.01	19.01	33.31
MCTG	10	1/2"	46.51	19.01	19.51	17.21	7.91	22.01	19.01	38.91
MCUC	12	1/4"	43.41	14.21	22.01	22.81	7.11	20.51	22.01	33.31
MCUF	12	3/8"	43.41	14.21	22.01	22.81	9.51	20.51	22.01	33.31
MCUG	12	1/2"	49.01	19.01	22.01	22.81	9.51	22.01	22.01	38.91
MCVF	16	3/8"	44.11	14.21	22.01	24.41	9.51	24.01	25.41	34.11
MCVG	16	1/2"	49.01	19.01	22.01	24.41	11.91	24.01	25.41	39.01
MCVJ	16	3/4"	50.51	19.01	22.01	24.41	12.71	27.01	25.41	40.41
MCWG	20	1/2"	52.31	19.01	22.01	26.01	11.91	32.01	32.01	42.21
MCWJ	20	3/4"	52.31	23.91	22.01	26.01	15.91	32.01	32.01	42.21
MCXJ	25	3/4"	57.51	19.01	26.51	31.31	15.91	35.01	38.01	45.21
MCXL	25	1"	62.31	23.91	26.51	31.31	21.81	35.01	38.01	50.01



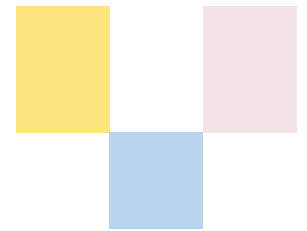

MALE CONNECTOR

Male Connector SAE/MS

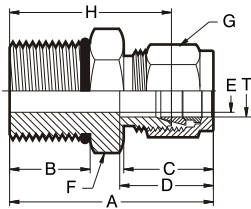

PART NO.	'T TUBE SAE/MS OD.	thread size	A ~	B ~	C ~	D ~	E MIN	F A/F	G A/F	H BODY
MCA1M	1/8"	7/16-20	1.25	0.37	0.61	0.51	0.10	9/16"	7/16"	0.99
MCA2M	1/8"	9/16-18	1.32	0.40	0.61	0.51	0.10	11/16"	7/16"	1.06
MCB1M	1/4"	7/16-20	1.35	0.37	0.71	0.61	0.20	9/16"	9/16"	1.06
MCB2M	1/4"	9/16-18	1.41	0.40	0.71	0.61	0.20	11/16"	9/16"	1.12
MCB4M	1/4"	3/4-16	1.49	0.45	0.71	0.61	0.20	7/8"	9/16"	1.20
MCB5M	1/4"	7/8-14	1.61	0.51	0.71	0.61	0.20	1"	9/16"	1.48
MCE6M	5/16"	1/2-20	1.38	0.37	0.74	0.65	0.26	5/8"	5/8"	1.09
MCC1M	3/8"	7/16-20	1.41	0.37	0.77	0.67	0.21	5/8"	11/16"	1.12
MCC2M	3/8"	9/16-18	1.47	0.40	0.77	0.67	0.29	11/16"	11/16"	1.18
MCC4M	3/8"	3/4-16	1.55	0.45	0.77	0.67	0.29	7/8"	11/16"	1.26
MCC5M	3/8"	7/8-14	1.67	0.51	0.77	0.67	0.29	1"	11/16"	1.38
MCE2M	1/2"	9/16-18	1.55	0.40	0.87	0.91	0.29	13/16"	7/8"	1.15
MCE4M	1/2"	3/4-16	1.66	0.45	0.87	0.91	0.42	7/8"	7/8"	1.26
MCE5M	1/2"	7/8-14	1.78	0.51	0.87	0.91	0.42	1"	7/8"	1.38
MCE7M	1/2"	11/16-12	1.94	0.60	0.87	0.91	0.42	1-1/4"	7/8"	1.54
MCH4M	5/8"	3/4-16	1.66	0.45	0.87	0.97	0.43	15/16"	1"	1.26
MCH5M	5/8"	7/8-14	1.79	0.51	0.87	0.97	0.51	1"	1"	1.39
MCF4M	3/4"	3/4-16	1.82	0.45	0.87	0.97	0.43	1-1/16"	1-1/8"	1.42
MCF7M	3/4"	11/16-12	1.94	0.60	0.87	0.97	0.63	1-1/4"	1-1/8"	1.54
MCL7M	1"	11/16-12	2.11	0.60	1.05	1.24	0.67	1-3/8"	1-1/2"	1.63
MCL8M	1"	15/16-12	2.15	0.60	1.05	1.24	0.89	1-1/2"	1-1/2"	1.67

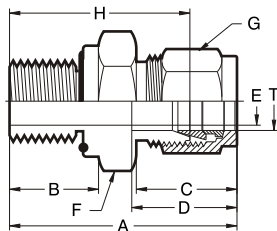

Male Connector O Seal Straight Thread

PART NO.	'T TUBE OD.	Pipe thread size	A ~	B ~	C ~	D ~	E MIN	F A/F	G A/F	H BODY
MCA3M	1/8"	5/16-24	1.30	0.35	0.61	0.51	0.10	9/16"	7/16"	1.04
MCC1M	1/4"	7/16-20	1.52	0.42	0.71	0.61	0.20	3/4"	9/16"	1.23
MCE6M	5/16"	1/2-20	1.61	0.45	0.74	0.65	0.26	7/8"	5/8"	1.32
MCF2M	3/8"	9/16-18	1.68	0.48	0.77	0.67	0.29	15/16"	11/16"	1.39
MCG4M	1/2"	3/4-16	1.82	0.48	0.87	0.91	0.42	11/8"	7/8"	1.42
MCJ7M	3/4"	11/16-12	2.07	0.57	0.87	0.97	0.63	11/2"	11/8"	1.67
MCL8M	1"	15/16-12	2.30	0.57	1.05	1.24	1.89	13/4"	11/2"	1.82

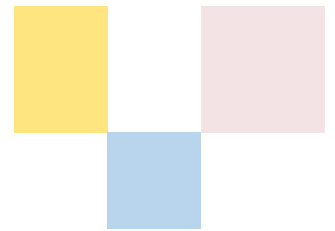

FEMALE CONNECTOR

Imperial Tubing										
PART NO.	TUBE OD 'T'	NPT. 'P'	A ~	B	C ~	D ~	E MIN	F A/F	G A/F	H BODY
FCAA	1/8"	1/8"	1.14	0.40	0.61	0.51	0.1	9/16"	7/16"	0.88
FCAC	1/8"	1/4"	1.33	0.60	0.61	0.51	0.1	3/4"	7/16"	1.07
FCBA	3/16"	1/8"	1.18	0.40	0.64	0.55	0.13	9/16"	1/2"	0.92
FCCA	1/4"	1/8"	1.24	0.40	0.71	0.61	0.2	9/16"	9/16"	0.95
FCCC	1/4"	1/4"	1.42	0.60	0.71	0.61	0.2	3/4"	9/16"	1.13
FCCF	1/4"	3/8"	1.49	0.60	0.71	0.61	0.2	7/8"	9/16"	1.20
FCCG	1/4"	1/2"	1.68	0.79	0.71	0.61	0.2	1-1/16"	9/16"	1.39
FCEA	5/16"	1/8"	1.27	0.40	0.74	0.65	0.26	9/16"	5/8"	0.98
FCEC	5/16"	1/4"	1.46	0.60	0.74	0.65	0.26	3/4"	5/8"	1.17
FCFC	3/8"	1/4"	1.49	0.60	0.77	0.67	0.29	3/4"	11/16"	1.20
FCFF	3/8"	3/8"	1.55	0.60	0.77	0.67	0.29	7/8"	11/16"	1.26
FCFG	3/8"	1/2"	1.74	0.79	0.77	0.67	0.29	1-1/16"	11/16"	1.45
FCGC	1/2"	1/4"	1.60	0.60	0.87	0.91	0.42	13/16"	7/8"	1.20
FCGF	1/2"	3/8"	1.66	0.60	0.87	0.91	0.42	7/8"	7/8"	1.26
FCGG	1/2"	1/2"	1.85	0.79	0.87	0.91	0.42	1-1/16"	7/8"	1.45
FCHF	5/8"	3/8"	1.66	0.60	0.87	0.97	0.51	15/16"	1"	1.26
FCHG	5/8"	1/2"	1.85	0.79	0.87	0.97	0.51	1-1/16"	1"	1.45
FCHJ	5/8"	3/4"	1.91	0.82	0.87	0.97	0.51	1-1/4"	1"	1.51
FCJG	3/4"	1/2"	1.85	0.79	0.87	0.97	0.63	1-1/16"	1-1/8"	1.45
FCJJ	3/4"	3/4"	2.91	0.82	0.87	0.97	0.63	1-1/4"	1-1/8"	1.51
FCJK	7/8"	3/4"	2.97	0.82	0.87	1.03	0.73	1-1/4"	1-1/4"	1.57
FCLJ	1"	3/4"	2.11	0.82	1.05	1.24	0.89	1-3/8"	1-1/2"	1.63
FCLL	1"	1"	2.46	1.01	1.05	1.24	0.89	1-5/8"	1-1/2"	1.98

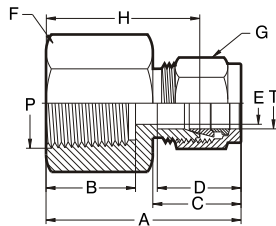

Metric Tubing										
PART NO.	TUBE OD	NPT.	A	B	C	D	E	F	G	H
FCPA	3	1/8"	28.71	9.71	15.31	12.91	2.41	14.01	12.71	22.11
FCPC	3	1/4"	34.01	14.21	15.31	12.91	2.41	19.01	12.71	27.01
FCQA	6	1/8"	31.21	9.71	17.71	15.31	4.81	14.01	14.01	23.91
FCQC	6	1/4"	35.81	14.21	17.71	15.31	4.81	19.01	14.01	28.61
FCQF	6	3/8"	37.61	14.21	17.71	15.31	4.81	22.01	14.01	30.21
FCQG	6	1/2"	42.51	19.01	17.71	15.31	4.81	27.01	14.01	35.11
FCRC	8	1/4"	37.01	14.21	18.61	16.21	6.31	19.01	16.01	29.51
FCRF	8	3/8"	38.51	14.21	18.61	16.21	6.31	22.01	16.01	31.01
FCRG	8	1/2"	43.31	19.01	18.61	16.21	6.31	27.01	16.01	35.81
FCTC	10	1/4"	37.81	14.21	19.51	17.21	7.11	19.01	19.01	30.51
FCTF	10	3/8"	39.41	14.21	19.51	17.21	7.91	22.01	19.01	31.81
FCTG	10	1/2"	44.21	19.01	19.51	17.21	7.91	27.01	19.01	36.61
FCUC	12	1/4"	40.31	14.21	22.01	22.81	9.51	20.51	22.01	30.21
FCUF	12	3/8"	42.91	14.21	22.01	22.81	9.51	22.01	22.01	31.81
FCUG	12	1/2"	46.71	19.01	22.01	22.81	9.51	27.01	22.01	36.61
FCVG	16	1/2"	46.91	19.01	22.01	24.41	12.71	27.01	25.41	36.61
FCWJ	20	3/4"	50.01	19.01	22.01	26.01	15.91	32.01	32.01	39.61
FCXJ	25	3/4"	53.41	19.01	26.51	31.31	15.91	36.01	38.01	41.21
FCXL	25	1"	62.31	23.91	26.51	31.31	21.91	41.01	38.01	50.01



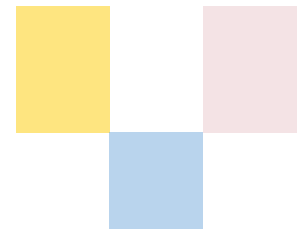

MALE BULKHEAD CONNECTOR

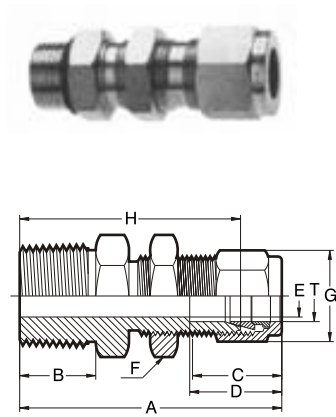

Imperial Tubing

PART NO.	TUBE OD. T'	NPT P'	A	H	C	D	E min	F A/F	B	Panel Hole Size	Max Panel Thk
BCMAA	1/8"	1/8"	1.84	1.58	0.98	0.51	0.1	1/2"	0.39	21/64"	0.51
BCMCA	1/4"	1/8"	1.96	1.67	1.04	0.61	0.2	5/8"	0.39	29/64"	0.41
BCMCC	1/4"	1/4"	2.14	1.85	1.04	0.61	0.2	5/4"	0.57	29/64"	0.41
BCMFC	3/8"	1/4"	2.27	1.98	1.17	0.67	0.29	3/4"	0.57	37/64"	0.45
BCMFF	3/8"	3/8"	2.27	1.98	1.17	0.67	0.29	3/4"	0.57	37/64"	0.45
BCMFG	3/8"	1/2"	2.52	2.23	1.17	0.67	0.29	7/8"	0.76	37/64"	0.45
BCMFG	1/2"	3/8"	2.50	3.00	1.26	0.91	0.39	15/16"	0.57	49/64"	0.51
BCMGG	1/2"	1/2"	2.72	2.32	1.26	0.91	0.42	15/16"	0.76	49/64"	0.51
BCMJJ	3/4"	3/4"	3.01	2.61	1.48	0.97	0.63	1-3/16"	0.76	1-1/64"	0.67
BCMLL	1"	1"	3.68	3.20	1.79	1.24	1.89	1-5/8"	0.95	1-21/64"	0.76

Metric Tubing

BCMQC	6	1/4"	53.61	46.21	26.21	15.31	4.81	16.01	14.01	11.51	10.21
BCMUG	12	1/2"	68.81	58.71	31.81	22.81	9.51	24.01	19.01	19.51	12.71

FEMALE BULKHEAD CONNECTOR

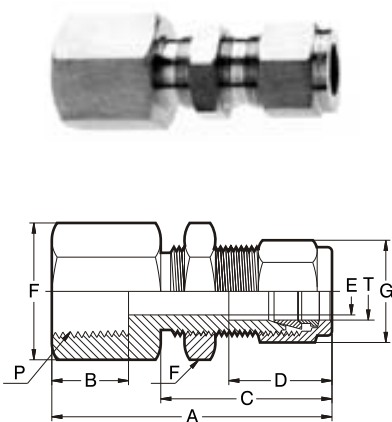

Imperial Tubing

PART NO.	TUBE OD. T'	NPT P'	A	H	C	D	E min	F A/F	B	Panel Hole Size	Max Panel Thk
BCFAA	1/8"	1/8"	1.77	1.51	0.98	0.51	0.1	9/16"	0.42	21/64"	0.51
BCFCA	1/4"	1/8"	1.86	1.57	1.04	0.61	0.2	5/8"	0.42	29/64"	0.41
BCFCC	1/4"	1/4"	2.05	1.76	1.04	0.61	0.2	3/4"	0.60	29/64"	0.41
BCFFC	3/8"	1/4"	2.18	1.89	1.17	0.67	0.29	3/4"	0.60	37/64"	0.45
BCFGF	1/2"	3/8"	2.44	2.04	1.26	0.91	0.39	15/16"	0.60	49/64"	0.51
BCFGG	1/2"	1/2"	2.63	2.23	1.26	0.91	0.42	1-1/16"	0.79	49/64"	0.51

Metric Tubing

BCFQC	6	1/4"	51.81	44.41	26.21	15.31	4.81	19.01	15.01	11.51	10.21
BCFUG	12	1/2"	66.51	56.41	31.81	22.81	9.51	27.01	19.81	19.51	12.71

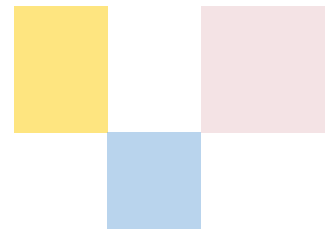

MALE ELBOW

Imperial Tubing

PART NO.	TUBE OD "T"	NPT. "P"	A ~	B	C ~	D ~	E MIN	F A/F	G A/F	Hx	H BODY
MEAA	1/8"	1/8"	0.98	0.39	0.61	0.51	0.1	1/2"	7/16"	0.75	0.72
MEAC	1/8"	1/4"	0.98	0.57	0.61	0.51	0.1	9/16"	7/16"	0.99	0.72
MEBC	3/16"	1/8"	1.01	0.39	0.64	0.55	0.13	1/2"	1/2"	0.75	0.75
MECA	1/4"	1/8"	1.14	0.39	0.71	0.61	0.2	9/16"	9/16"	0.86	0.85
MECC	1/4"	1/4"	1.14	0.57	0.71	0.61	0.2	9/16"	9/16"	0.99	0.85
MECF	1/4"	3/8"	1.18	0.57	0.71	0.61	0.2	11/16"	9/16"	1.04	0.89
MECG	1/4"	1/2"	1.30	0.76	0.71	0.61	0.2	7/8"	9/16"	1.31	1.01
MEEA	5/16"	1/8"	1.14	0.39	0.74	0.74	0.2	9/16"	5/8"	0.86	0.85
MEEC	5/16"	1/4"	1.14	0.57	0.74	0.74	0.26	9/16"	5/8"	0.99	0.85
MEFC	3/8"	1/4"	1.21	0.57	0.77	0.67	0.29	9/16"	11/16"	1.01	0.92
MEFF	3/8"	3/8"	1.24	0.57	0.77	0.67	0.29	11/16"	11/16"	1.04	0.95
MEFG	3/8"	1/2"	1.36	0.76	0.77	0.67	0.29	7/8"	11/16"	1.31	1.07
MEGC	1/2"	1/4"	1.43	0.57	0.87	0.91	0.29	13/16"	7/8"	1.12	1.03
MEGF	1/2"	3/8"	1.43	0.57	0.87	0.91	0.39	13/16"	7/8"	1.12	1.03
MEGG	1/2"	1/2"	1.43	0.76	0.87	0.91	0.42	7/8"	7/8"	1.31	1.03
MEHF	5/8"	3/8"	1.47	0.76	0.87	0.97	0.39	15/16"	1"	1.20	1.07
MEHG	5/8"	1/2"	1.47	0.76	0.87	0.97	0.48	15/16"	1"	1.39	1.07
MEHJ	5/8"	3/4"	1.58	0.76	0.87	0.97	0.51	1-1/8"	1"	1.46	1.18
MEJG	3/4"	1/2"	1.58	0.76	0.87	0.97	0.47	1-1/8"	1-1/8"	1.46	1.18
MEJJ	3/4"	3/4"	1.58	0.76	0.87	0.97	0.63	1-1/8"	1-1/8"	1.46	1.18
MEKJ	7/8"	3/4"	1.77	0.76	0.87	1.03	0.63	1-1/4"	1-1/4"	1.65	1.37
MELJ	1"	3/4"	1.93	0.76	1.05	1.24	0.64	1-3/8"	1-1/2"	1.65	1.46
MELL	1"	1"	1.93	0.95	1.05	1.24	0.89	1-3/8"	1-1/2"	1.84	1.46

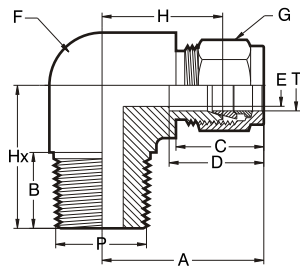
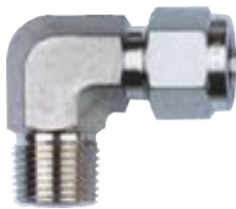

Metric Size Tubing

MEPA	3	1/8"	24.7	9.71	15.31	12.91	2.41	12.71	11.01	18.81	18.01
MEPC	3	1/4"	24.7	14.21	15.31	12.91	7.11	12.71	11.01	25.01	18.01
MEQA	6	1/8"	28.8	9.71	17.71	15.31	4.81	14.01	14.01	21.51	21.31
MEQC	6	1/4"	28.8	14.21	17.71	15.31	4.81	14.01	14.01	25.01	21.31
MEQF	6	3/8"	29.9	14.21	17.71	15.31	4.81	17.01	14.01	26.21	22.41
MEQG	6	1/2"	33.0	19.01	17.71	15.31	4.81	22.01	14.01	33.01	25.51
MERA	8	1/8"	28.9	9.71	18.61	16.21	4.81	14.01	16.01	21.51	21.31
MERC	8	1/4"	28.9	14.21	18.61	16.21	6.31	14.01	16.01	25.01	21.31
MERF	8	3/8"	30.7	14.21	18.61	16.21	6.31	17.01	16.01	26.21	23.11
MERG	8	1/2"	32.7	19.01	18.61	16.21	6.31	22.01	16.01	33.01	25.11
METC	10	1/4"	31.6	14.21	19.51	17.21	7.11	17.01	19.01	26.21	23.91
METF	10	3/8"	31.6	14.21	19.51	17.21	7.91	17.01	19.01	26.21	23.91
METG	10	1/2"	33.6	19.01	19.51	17.21	7.91	22.01	19.01	33.01	25.91
MEUF	12	3/8"	36.1	14.21	22.01	22.81	9.51	20.51	22.01	28.21	25.91
MEUG	12	1/2"	36.1	19.01	22.01	22.81	9.51	22.01	22.01	33.01	25.91
MEVG	16	1/2"	37.2	19.01	22.01	24.41	12.71	24.01	25.01	35.11	27.01
MEWJ	20	3/4"	44.7	19.01	22.01	26.01	15.91	32.01	32.01	41.71	34.51
MEXJ	25	3/4"	49.2	19.01	26.51	31.31	15.91	36.01	38.11	41.71	36.81
MEXL	25	1"	49.2	23.81	26.51	31.31	21.81	36.01	38.11	46.51	36.81





FEMALE ELBOW

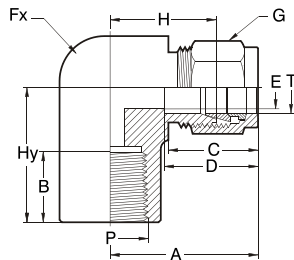

Imperial Tubing

PART NO.	TUBE OD 'T'	NPT FEMALE 'P'	A ~	B	C	D ~	E MIN	Fx A/F	Gx A/F	Hy	Hx BODY
FEAA	1/8"	1/8"	0.98	0.40	0.61	0.51	0.1	9/16"	7/16"	0.76	0.72
FEAC	1/8"	1/4"	1.09	0.60	0.61	0.51	0.1	3/4"	7/16"	0.89	0.83
FECA	1/4"	1/8"	1.07	0.40	0.71	0.61	0.2	9/16"	9/16"	0.76	0.78
FECC	1/4"	1/4"	1.18	0.60	0.71	0.61	0.2	3/4"	9/16"	0.89	0.89
FECF	1/4"	3/8"	1.26	0.60	0.71	0.61	0.2	7/8"	9/16"	0.89	0.96
FECG	1/4"	1/2"	1.37	0.79	0.71	0.61	0.2	1-1/16"	9/16"	1.13	1.08
FEHC	5/16"	1/4"	1.21	0.60	0.74	0.65	0.26	3/4"	5/8"	0.89	0.92
FEFC	3/8"	1/4"	1.24	0.60	0.77	0.67	0.29	3/4"	11/16"	0.89	0.95
FEFF	3/8"	3/8"	1.32	0.60	0.77	0.67	0.29	7/8"	11/16"	0.89	1.03
FEFG	3/8"	1/2"	1.43	0.79	0.77	0.67	0.29	1-1/16"	11/16"	1.13	1.14
FEGC	1/2"	1/4"	1.43	0.60	0.87	0.91	0.42	13/16"	7/8"	0.89	1.03
FECG	1/2"	3/8"	1.43	0.60	0.87	0.91	0.42	7/8"	7/8"	0.89	1.03
FECC	1/2"	1/2"	1.54	0.79	0.87	0.91	0.42	1-1/16"	7/8"	1.13	1.14
FEHC	5/8"	1/2"	1.58	0.79	0.87	0.97	0.51	1-1/16"	1"	1.13	1.18
FEJC	3/4"	1/2"	1.58	0.79	0.87	0.97	0.63	1-1/16"	1-1/8"	1.13	1.18
FEJJ	3/4"	3/4"	1.77	0.82	0.87	0.97	0.63	1-1/4"	1-1/8"	1.26	1.37

Metric Tubing

FEPA	3	1/8"	24.7	9.71	15.31	12.91	2.41	14.01	11.01	19.01	18.01
FEPC	3	1/4"	27.1	14.21	15.31	12.91	2.41	19.01	11.01	22.41	20.81
FEQA	6	1/8"	27.1	9.71	17.71	15.31	4.81	14.01	14.01	19.01	19.61
FEQC	6	1/4"	29.9	14.21	17.71	15.31	4.81	19.01	14.01	22.41	22.41
FEQF	6	3/8"	31.8	14.21	17.71	15.31	4.81	22.01	14.01	22.41	24.41
FEQG	6	1/2"	34.7	19.01	17.71	15.31	4.81	27.01	14.01	28.41	27.21
FERC	8	1/4"	30.7	14.21	18.61	16.21	6.31	19.01	16.01	22.41	23.11
FETC	10	1/4"	33.6	14.21	19.51	17.21	7.11	19.01	19.01	22.41	25.91
FEUC	12	1/4"	36.1	14.21	22.01	22.91	9.51	20.51	22.01	22.41	25.91
FEUF	12	3/8"	36.1	14.21	22.01	22.91	9.51	22.01	22.01	22.41	25.91
FEUG	12	1/2"	38.9	19.01	22.01	22.91	9.51	27.01	22.01	28.41	28.71
FEVG	16	1/2"	39.6	19.01	22.01	24.41	12.71	27.01	25.01	28.41	29.71

45° MALE ELBOW

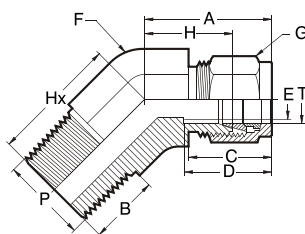

Imperial Tubing

PART NO.	TUBE OD 'T'	NPT. 'P'	A ~	B	C ~	D ~	E MIN	F A/F	G A/F	Hx	H BODY
45IMEAA	1/8"	1/8"	0.98	0.39	0.61	0.51	0.1	9/16"	7/16"	0.60	0.66
45IMECA	1/4"	1/8"	0.98	0.39	0.71	0.61	0.2	9/16"	9/16"	0.69	0.66
45IMECC	1/4"	1/4"	0.98	0.57	0.71	0.61	0.2	9/16"	9/16"	0.69	0.84
45IMEEA	5/16"	1/8"	0.98	0.39	0.74	0.65	0.2	9/16"	5/8"	0.67	0.66
45IMEFA	3/8"	1/8"	1.11	0.39	0.77	0.67	0.2	9/16"	11/16"	0.82	0.73
45IMEFC	3/8"	1/4"	1.11	0.57	0.77	0.67	0.29	5/8"	11/16"	0.82	0.91
45IMEFF	3/8"	3/8"	1.16	0.57	0.77	0.67	0.29	11/16"	11/16"	0.87	0.96
45IMEGF	1/2"	3/8"	1.27	0.57	0.87	0.91	0.39	13/16"	7/8"	0.87	0.96
45IMEGG	1/2"	1/2"	1.27	0.76	0.87	0.91	0.42	7/8"	7/8"	0.87	1.15
45IMEHG	5/8"	1/2"	1.35	0.76	0.87	0.97	0.48	15/16"	1"	0.82	1.18
45IMEJJ	3/4"	3/4"	1.35	0.76	0.87	0.97	0.63	1-1/8"	1-1/8"	0.95	1.23
45IMEKJ	7/8"	3/4"	1.60	0.76	0.87	1.03	0.63	1-1/4"	1-1/4"	1.37	1.28
45IMELL	1"	1"	1.60	0.95	1.05	1.24	0.89	1-3/8"	1-1/2"	1.12	1.50

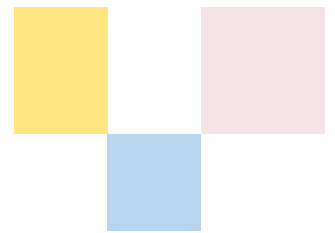

MALE BRANCH TEE

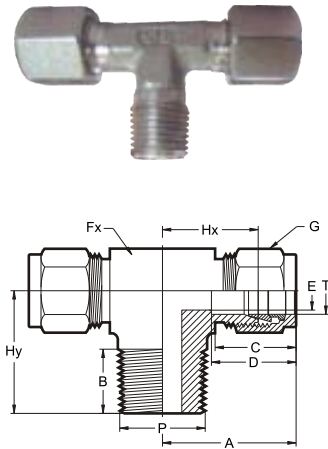

Imperial Tubing

PART NO.	TUBE OD	NPT. 'P'	A ~	B	C ~	D ~	E MIN	F A/F	G A/F	Hy	Hx BODY
BTMAA	1/8"	1/8"	0.94	0.39	0.61	0.51	0.1	1/2"	7/16"	0.71	0.68
BTMAC	1/8"	1/4"	0.98	0.57	0.61	0.51	0.1	9/16"	7/16"	0.93	0.72
BTMCA	1/4"	1/8"	1.07	0.39	0.71	0.61	0.2	1/2"	9/16"	0.75	0.78
BTMCC	1/4"	1/4"	1.07	0.57	0.71	0.61	0.2	9/16"	9/16"	0.93	0.78
BTMEC	5/16"	1/4"	1.18	0.57	0.74	0.65	0.26	9/16"	5/8"	0.93	0.89
BTMFC	3/8"	1/4"	1.21	0.57	0.77	0.67	0.29	9/16"	11/16"	1.01	0.92
BTMFF	3/8"	3/8"	1.32	0.57	0.77	0.67	0.29	11/16"	11/16"	1.12	1.03
BTMGF	1/2"	3/8"	1.43	0.57	0.87	0.91	0.39	13/16"	7/8"	1.12	1.03
BTMGG	1/2"	1/2"	1.43	0.76	0.87	0.91	0.42	7/8"	7/8"	1.31	1.03
BTMHG	5/8"	1/2"	1.54	0.76	0.87	0.97	0.48	15/16"	1"	1.42	1.14
BTMJJ	3/4"	3/4"	1.58	0.76	0.87	0.97	0.63	1-1/16"	1-1/8"	1.46	1.18

Metric Tubing

PART NO.	TUBE OD	NPT. 'P'	A	B	C	D	E	F	G	Hy	Hx
BTMPA	3	1/8"	23.61	9.71	15.31	12.91	2.41	12.71	11.01	17.81	17.01
BTMPC	3	1/4"	23.61	14.21	15.31	12.91	2.41	14.01	11.01	23.41	18.01
BTMQA	6	1/8"	26.91	9.71	17.71	15.4	4.81	12.71	14.01	18.81	19.61
BTMQC	6	1/4"	26.91	14.21	17.71	15.4	4.81	14.01	14.01	23.41	19.61
BTMRA	8	1/8"	29.81	9.71	18.61	16.3	4.81	14.01	16.01	19.01	22.41
BTMRC	8	1/4"	29.81	14.21	18.61	16.3	6.31	14.01	16.01	23.41	22.41
BTMTC	10	1/4"	33.51	14.21	19.51	17.3	7.11	17.01	19.01	28.21	25.91
BTMTF	10	3/8"	33.51	14.21	19.51	17.3	7.91	17.01	19.01	28.21	25.91
BTMUF	12	3/8"	36.01	14.21	22.01	22.9	9.51	20.51	22.01	28.21	25.91
BTMUG	12	1/2"	36.01	19.01	22.01	22.9	9.51	22.01	22.01	33.01	25.91
BTMVG	16	1/2"	38.81	19.01	22.01	24.5	12.71	24.01	25.01	35.81	28.71

MALE RUN TEE

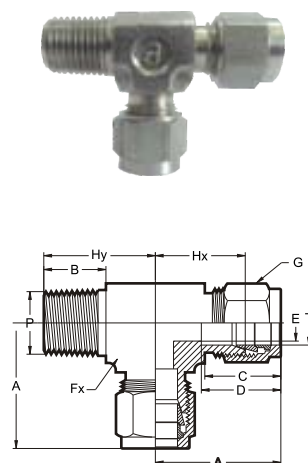

Imperial Tubing

PART NO.	TUBE OD	NPT. 'P'	A	B	C	D	E MIN	F A/F	G A/F	Hy	Hx BODY
RTMAA	1/8"	1/8"	0.94	0.39	0.61	0.51	0.1	1/2"	7/16"	0.71	0.68
RTMAC	1/8"	1/4"	0.98	0.57	0.61	0.51	0.1	9/16"	7/16"	0.93	0.72
RTMCA	1/4"	1/8"	1.07	0.39	0.71	0.61	0.2	1/2"	9/16"	0.75	0.78
RTMCC	1/4"	1/4"	1.07	0.57	0.71	0.61	0.2	9/16"	9/16"	0.93	0.78
RTMEC	5/16"	1/4"	1.18	0.57	0.74	0.65	0.26	9/16"	5/8"	0.93	0.89
RTMFC	3/8"	1/4"	1.21	0.57	0.77	0.67	0.29	9/16"	11/16"	1.01	0.92
RTMFF	3/8"	3/8"	1.32	0.57	0.77	0.67	0.29	11/16"	11/16"	1.12	1.03
RTMGF	1/2"	3/8"	1.43	0.57	0.87	0.91	0.39	13/16"	7/8"	1.12	1.03
RTMGG	1/2"	1/2"	1.43	0.76	0.87	0.91	0.42	7/8"	7/8"	1.31	1.03
RTMHG	5/8"	1/2"	1.54	0.76	0.87	0.97	0.48	15/16"	1"	1.42	1.14
RTMJJ	3/4"	3/4"	1.58	0.76	0.87	0.97	0.63	1-1/16"	1-1/8"	1.46	1.18

Metric Tubing

PART NO.	TUBE OD	NPT. 'P'	A	B	C	D	E	F	G	Hy	Hx
RTMPA	3	1/8"	23.61	9.71	15.31	12.91	2.41	12.71	11.01	17.81	17.01
RTMOC	3	1/4"	23.61	14.21	15.31	12.91	2.41	14.01	11.01	23.41	18.01
RTMQA	6	1/8"	26.91	9.71	17.71	15.4	4.81	12.71	14.01	18.81	19.61
RTMQC	6	1/4"	26.91	14.21	17.71	15.4	4.81	14.01	14.01	23.41	19.61
RTMRA	8	1/8"	29.81	9.71	18.61	16.3	4.81	14.01	16.01	19.01	22.41
RTMRC	8	1/4"	29.81	14.21	18.61	16.3	6.31	14.01	16.01	23.41	22.41
RTMTC	10	1/4"	33.51	14.21	19.51	17.3	7.11	17.01	19.01	28.21	25.91
RTMTF	10	3/8"	33.51	14.21	19.51	17.3	7.91	17.01	19.01	28.21	25.91
RTMUF	12	3/8"	36.01	14.21	22.01	22.9	9.51	20.51	22.01	28.21	25.91
RTMUG	12	1/2"	36.01	19.01	22.01	22.9	9.51	22.01	22.01	33.01	25.91
RTMVG	16	1/2"	38.81	19.01	22.01	24.5	12.71	24.01	25.01	35.81	28.71



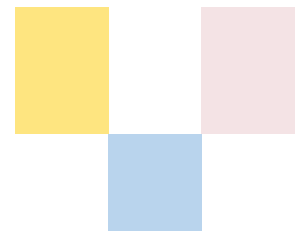

FEMALE BRANCH TEE

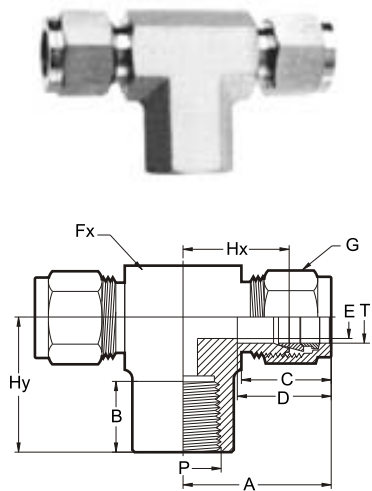

Imperial Tubing

PART NO.	TUBE NPT. OD 'T'	'P'	A ~	B	C ~	D ~	E MIN	F A/F	G A/F	Hy ~	Hx BODY
BTFAA	1/8"	1/8"	0.98	0.40	0.61	0.51	0.1	9/16"	7/16"	0.76	0.72
BTFCA	1/4"	1/8"	1.07	0.40	0.71	0.61	0.2	9/16"	9/16"	0.76	0.78
BT FCC	1/4"	1/4"	1.18	0.60	0.71	0.61	0.2	3/4"	9/16"	0.89	0.89
BT FEC	5/16"	1/4"	1.21	0.60	0.74	0.65	0.26	3/4"	5/8"	0.89	0.91
BT FFC	3/8"	1/4"	1.24	0.60	0.77	0.67	0.29	3/4"	11/16"	0.89	0.94
BT FFF	3/8"	3/8"	1.32	0.60	0.77	0.67	0.29	7/8"	11/16"	0.89	1.03
BT FGC	1/2"	1/4"	1.43	0.60	0.87	0.91	0.42	13/16"	7/8"	0.89	1.03
BT FGF	1/2"	3/8"	1.43	0.60	0.87	0.91	0.42	7/8"	7/8"	0.89	1.03
BT FGG	1/2"	1/2"	1.54	0.79	0.87	0.91	0.42	1-1/16"	7/8"	1.13	1.14
BT FHG	5/8"	1/2"	1.58	0.79	0.87	0.97	0.51	1-1/16"	1"	1.13	1.18
BT FJG	3/4"	1/2"	1.58	0.79	0.87	0.97	0.63	1-1/16"	1-1/8"	1.13	1.18
BT FJJ	3/4"	3/4"	1.77	0.82	0.87	0.97	0.63	1-1/4"	1-1/8"	1.26	1.37

Metric Tubing

BT FQA	6	1/8"	27.1	9.71	17.8	15.4	4.9	14.01	14.01	19.11	19.61
BT FQC	6	1/4"	29.9	14.3	17.8	15.4	4.9	19.01	14.01	22.51	22.41
BT FRA	8	1/8"	29.8	10.5	18.7	16.3	6.4	15.01	16.01	22.51	19.61
BT FRC	8	1/4"	30.7	14.3	18.7	16.3	6.4	19.01	16.01	22.51	23.11
BT FTC	10	1/4"	33.6	14.3	19.6	17.3	7.1	19.01	19.01	22.51	25.91
BT FUC	12	1/4"	36.1	14.3	22.1	22.9	9.6	20.51	22.01	22.51	25.91
BT FUF	12	3/8"	36.1	14.3	22.1	22.9	9.6	22.01	22.01	22.51	25.91
BT FVG	16	1/2"	39.6	19.1	22.1	24.5	12.8	27.01	25.01	28.51	29.71

FEMALE RUN TEE

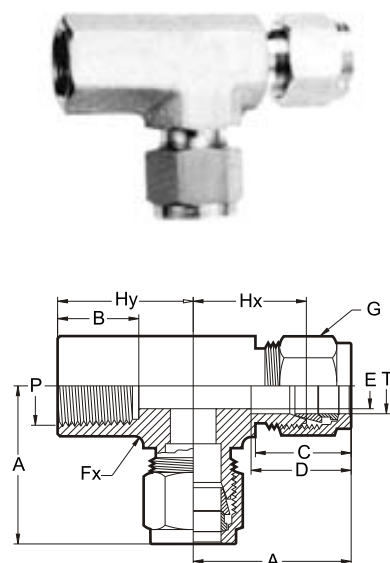

Imperial Tubing

PART NO.	TUBE NPT. OD 'T'	'P'	A ~	B	C ~	D ~	E MIN	F A/F	G A/F	Hy ~	Hx BODY
RTFAA	1/8"	1/8"	0.98	0.40	0.61	0.51	0.1	9/16"	7/16"	0.76	0.72
RTFCA	1/4"	1/8"	1.07	0.40	0.71	0.61	0.2	9/16"	9/16"	0.76	0.78
RT FCC	1/4"	1/4"	1.18	0.60	0.71	0.61	0.2	3/4"	9/16"	0.89	0.89
RT FEC	5/16"	1/4"	1.21	0.60	0.74	0.65	0.26	3/4"	5/8"	0.89	0.91
RT FFC	3/8"	1/4"	1.24	0.60	0.77	0.67	0.29	3/4"	11/16"	0.89	0.94
RT FFF	3/8"	3/8"	1.32	0.60	0.77	0.67	0.29	7/8"	11/16"	0.89	1.03
RT FGC	1/2"	1/4"	1.43	0.60	0.87	0.91	0.42	13/16"	7/8"	0.89	1.03
RT FGF	1/2"	3/8"	1.43	0.60	0.87	0.91	0.42	7/8"	7/8"	0.89	1.03
RT FGG	1/2"	1/2"	1.54	0.79	0.87	0.91	0.42	1-1/16"	7/8"	1.13	1.14
RT FHG	5/8"	1/2"	1.58	0.79	0.87	0.97	0.51	1-1/16"	1"	1.13	1.18
RT FJG	3/4"	1/2"	1.58	0.79	0.87	0.97	0.63	1-1/16"	1-1/8"	1.13	1.18
RT FJJ	3/4"	3/4"	1.77	0.82	0.87	0.97	0.63	1-1/4"	1-1/8"	1.26	1.37

Metric Tubing

RT FQA	6	1/8"	27.1	9.71	17.8	15.4	4.9	14.1	14.1	19.1	19.7
RT FQC	6	1/4"	29.9	14.3	17.8	15.4	4.9	19.1	14.1	22.5	22.5
RT FRA	8	1/8"	29.8	10.5	18.7	16.3	6.4	15.1	16.1	22.5	19.7
RT FRC	8	1/4"	30.7	14.3	18.7	16.3	6.4	19.1	16.1	22.5	23.2
RT FTC	10	1/4"	33.6	14.3	19.6	17.3	7.1	19.1	19.1	22.5	25.91
RT FUC	12	1/4"	36.1	14.3	22.1	22.9	9.6	20.6	22.1	22.5	25.91
RT FUF	12	3/8"	36.1	14.3	22.1	22.9	9.6	22.1	22.1	22.5	25.91

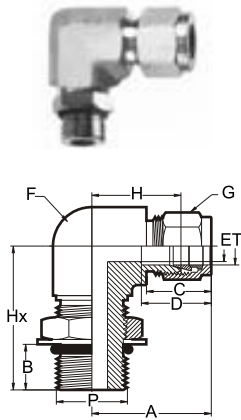
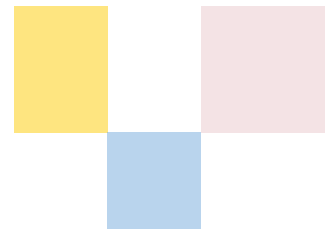

POSITIONABLE MALE ELBOW

Imperial Tubing

PART NO.	TUBE OD 'T'	Pipe thread size	A ~	B	C ~	D ~	E MIN	F A/F	G A/F	Hx	H BODY
PEMC1	1/4"	7/16-20	1.13	0.40	0.71	0.61	0.20	9/16"	9/16"	1.13	0.85
PEMC2	1/4"	9/16-18	1.21	0.45	0.71	0.61	0.20	5/8"	11/16"	1.28	0.92
PEME6	5/16"	1/2-20	1.20	0.40	0.74	0.65	0.24	9/16"	5/8"	1.17	0.91
PEMF2	3/8"	9/16-18	1.27	0.45	0.76	0.67	0.29	5/8"	11/16"	1.28	0.98
PEMF4	3/8"	3/4-16	1.38	0.51	0.76	0.67	0.29	13/16"	7/8"	1.50	1.09
PEMG4	1/2"	3/4-16	1.49	0.51	0.87	0.91	0.42	13/16"	7/8"	1.50	1.09
PEMH5	5/8"	7/8-14	1.57	0.57	0.87	0.96	0.51	15/16"	1"	1.72	1.17
PEMJ7	3/4"	11/16-12	1.64	0.67	0.87	0.96	0.63	1-1/16"	1-1/8"	1.93	1.24
PEMK9	7/8"	13/16-12	1.71	0.67	0.87	1.03	1.73	1-3/16"	1-1/4"	2	1.31
PEML8	1"	15/16-12	2	0.67	1.05	1.24	1.89	1-3/8"	1-1/2"	2.12	1.52

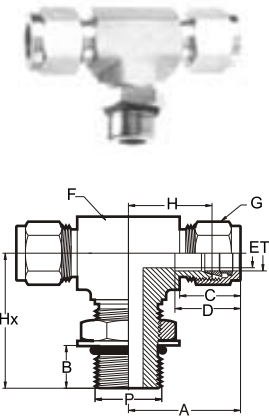

POSITIONABLE MALE BRANCH TEE

Imperial Tubing

PART NO.	TUBE OD 'T'	Pipe thread size	A ~	B	C ~	D ~	E MIN	F A/F	G A/F	Hx	H BODY
PBTMC1	1/4"	7/16-20	1.13	0.40	0.71	0.61	0.20	9/16"	9/16"	1.13	0.85
PBTMF2	3/8"	9/16-18	1.27	0.45	0.77	0.67	0.29	5/8"	11/16"	1.28	0.98
PBTMG4	1/2"	3/4-16	1.49	0.51	0.87	0.91	0.42	13/16"	7/8"	1.50	1.09
PBTMJ7	3/4"	11/16-12	1.64	0.67	0.87	0.97	0.63	1-1/16"	1-1/8"	1.93	1.24
PBTML8	1"	15/16-12	0.2	0.67	1.05	1.24	0.89	1-3/8"	1-1/2"	2.12	1.52

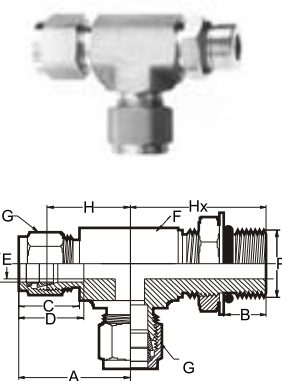

POSITIONABLE MALE RUN TEE

Imperial Tubing

PART NO.	TUBE OD 'T'	Pipe thread size	A ~	B	C ~	D ~	E MIN	F A/F	G A/F	Hx	H BODY
PRTMC1	1/4"	7/16-20	1.13	0.40	0.71	0.61	0.20	9/16"	9/16"	1.13	0.85
PRTMF2	3/8"	9/16-18	1.27	0.45	0.77	0.67	0.29	5/8"	11/16"	1.28	0.98
PRTMG4	1/2"	3/4-16	1.49	0.51	0.87	0.91	0.42	13/16"	7/8"	1.50	1.09
PRTMJ7	3/4"	11/16-12	1.64	0.67	0.87	0.97	0.63	1-1/16"	1-1/8"	1.93	1.24
PRTML8	1"	15/16-12	0.2	0.67	1.05	1.24	0.89	1-3/8"	1-1/2"	2.12	1.52



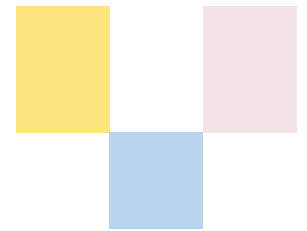

OD CAP

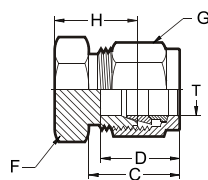

Imperial Tubing						
PART NO.	T TUBE OD	A ~	C ~	D ~	Fx A/F	G A/F
ODCA	1/8"	0.80	0.61	0.51	7/16"	7/16"
ODCB	3/16"	0.85	0.64	0.65	7/16"	1/2"
ODCC	1/4"	0.93	0.71	0.61	1/2"	9/16"
ODCE	5/16"	0.97	0.74	0.65	9/16"	5/8"
ODCF	3/8"	1.02	0.77	0.67	5/8"	11/16"
ODCG	1/2"	1.16	0.87	0.91	13/16"	7/8"
ODCH	5/8"	1.19	0.87	0.97	15/16"	1"
ODCJ	3/4"	1.25	0.87	0.97	1-1/16"	1-1/8"
ODCK	7/8"	1.35	0.87	1.03	1-1/4"	1-1/4"
ODCV	1"	1.52	1.05	1.24	1-3/8"	1-1/2"

Metric Tubing						
PART NO.	T TUBE OD	A ~	C ~	D ~	Fx A/F	G A/F
ODCP	3	20.11	12.91	12.71	11.01	11.01
ODCQ	6	23.11	15.31	15.31	14.01	14.01
ODCR	8	24.51	16.21	16.31	14.01	16.01
ODCT	10	26.61	17.21	17.51	17.01	19.01
ODCU	12	29.11	23.01	22.91	20.61	22.01
ODCV	16	29.91	24.61	24.41	24.01	25.41
ODCW	20	34.01	26.11	25.91	30.01	32.01
ODCX	25	38.51	31.21	31.21	35.01	38.01

OD PLUG

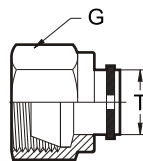

Inch size tubing			
PART NO.	T TUBE OD	G A/F	
ODPA	1/8"	7/16	
ODPB	3/16"	1/2	
ODCC	1/4"	9/16	
ODCE	5/16"	5/8	
ODCF	3/8"	11/16	
ODCG	1/2"	7/8	
ODCH	5/8"	1	
ODCJ	3/4"	1-1/8	
ODCK	7/8"	1-1/4	
ODCL	1"	1-1/2	

Metric Tubing			
PART NO.	T TUBE OD	G A/F	
ODPP	3	11.01	
ODCQ	6	14.01	
ODCR	8	16.01	
ODCT	10	19.01	
ODCU	12	22.01	
ODCV	16	25.41	
ODCW	20	32.01	
ODCX	25	38.01	

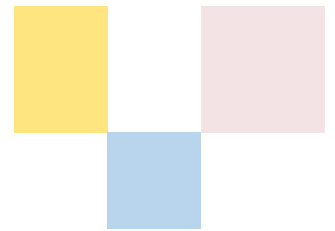

REDUCER

Reducer Imperial Tubing								
PART NO.	T'TUBE OD.	Tx TubeOD	A ~	C ~	D ~	E MIN	F A/F	G A/F
RAC	1/8"	1/4"	1.43	0.61	0.51	0.10	7/16"	7/16"
RBC	3/16"	1/4"	1.47	0.64	0.55	0.13	7/16"	1/2"
RCF	1/4"	3/8"	1.61	0.71	0.61	0.20	1/2"	9/16"
RCG	1/4"	1/2"	1.83	0.71	0.61	0.20	9/16"	9/16"
REF	5/16"	3/8"	1.66	0.74	0.65	0.26	9/16"	5/8"
RFC	3/8"	1/4"	1.64	0.77	0.67	0.20	5/8"	11/16"
RFG	3/8"	1/2"	1.92	0.77	0.67	0.29	5/8"	11/16"
RGC	1/2"	1/4"	1.78	0.87	0.91	0.20	13/16"	7/8"
RGF	1/2"	3/8"	1.85	0.87	0.91	0.29	13/16"	7/8"
RGJ	1/2"	3/4"	2.13	0.87	0.91	0.42	13/16"	7/8"
RHJ	5/8"	3/4"	2.16	0.87	0.97	0.52	15/16"	1"
RJG	3/4"	1/2"	2.16	0.87	0.97	0.40	1-1/16"	1-1/8"
RJL	3/4"	1"	2.47	0.87	0.97	0.63	1-1/16"	1-1/8"

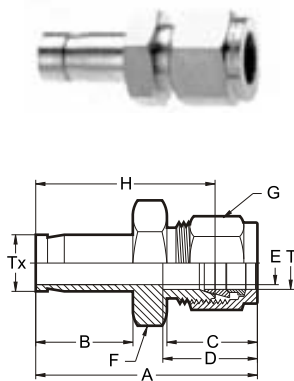

Reducer Metric Tubing								
PART NO.	T'TUBE OD.	Tx TubeOD	A ~	C ~	D ~	E MIN	F A/F	G A/F
RMQR	6	8	39.91	17.71	15.31	4.81	14.01	14.01
RMQT	6	10	40.71	17.71	15.31	4.81	14.01	14.01
RMQU	6	12	46.31	17.71	15.31	4.81	14.01	14.01
RMRT	8	10	42.01	18.61	16.21	6.31	15.01	16.01
RMRU	8	12	47.61	18.61	16.21	6.31	15.01	16.01
RMTR	10	8	43.41	19.51	17.21	7.91	18.01	19.01
RMTU	10	12	49.81	19.51	17.21	7.91	18.01	19.01
RMUT	12	10	46.71	22.01	22.81	7.71	22.01	22.01
RMUV	12	16	53.81	22.01	22.81	9.51	22.01	22.01
RMWV	20	16	57.91	22.01	26.01	12.71	30.01	32.01
RMWX	20	25	64.21	22.01	26.01	15.11	30.01	32.01
RMXW	25	20	64.61	26.51	31.31	15.11	35.01	38.11

PORT CONNECTOR

Inch size tubing				
PART NO.	T'TUBE OD	H	J	E Min
PCA	1/8"	0.89	0.25	0.10
PCC	1/4"	0.98	0.38	0.20
PCE	5/16"	1.03	0.44	0.26
PCF	3/8"	1.04	0.51	0.31
PCG	1/2"	1.42	0.63	0.40
PCJ	3/4"	1.48	0.88	0.60
PCL	1"	1.90	1.13	0.81

Metric Tubing				
PART NO.	T'TUBE OD	H	J	E Min
PCQ	6	24.6	9.0	4.5
PCR	8	25.9	11.0	6.3
PCT	10	26.1	13.1	8.3
PCU	12	35.8	15.0	9.2
PCV	16	37.4	19.0	12.8
PCW	20	38.9	23.0	15.2
PCX	25	48.0	28.0	19.9

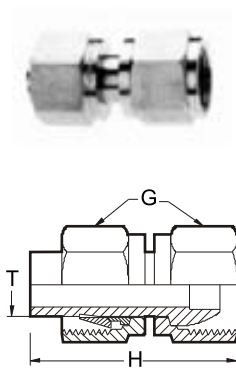

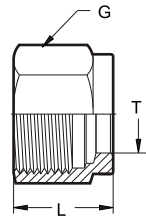
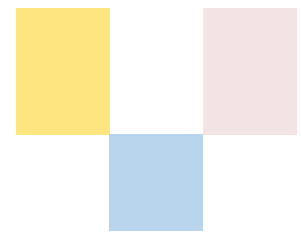

NUT

Inch size tubing			
PART NO.	TUBE OD T'	G A/F	L
NTA	1/8"	7/16"	0.47
NTB	3/16"	1/2"	0.47
NTC	1/4"	9/16"	0.50
NTE	5/16"	5/8"	0.53
NTF	3/8"	11/16"	0.56
NTG	1/2"	7/8"	0.69
NTH	5/8"	1"	0.69
NTJ	3/4"	1-1/8"	0.69
NTK	7/8"	1-1/4"	0.69
NTL	1"	1-1/2"	0.81

Metric Tubing			
PART NO.	TUBE OD T'	G A/F	L
NTP	3	11.0	11.9
NTQ	6	14.0	12.7
NTR	8	16.0	13.5
NTT	10	19.0	15.1
NTU	12	22.0	17.4
NTV	16	25.0	17.4
NTW	20	32.0	17.4
NTX	25	38.0	20.6

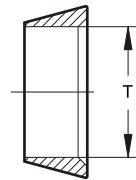

FRONT TEE R RULE

Inch size tubing	
PART NO.	T'TUBE OD
FTA	1/8"
FTC	1/4"
FTE	5/16"
FTF	3/8"
FTG	1/2"
FTH	5/8"
FTJ	3/4"
FTK	7/8"
FTL	1"

Metric Size Tubing	
PART NO.	T'TUBE OD
FTP	3
FTQ	6
FTR	8
FTT	10
FTU	12
FTV	16
FTW	20
FTX	25

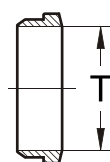

BACK FERRULE

Inch size tubing	
PART NO.	T'TUBE OD
BFA	1/8"
BFC	1/4"
BFE	5/16"
BFF	3/8"
BFG	1/2"
BFH	5/8"
BFJ	3/4"
BFK	7/8"
BFL	1"

Metric Size Tubing	
PART NO.	T'TUBE OD
BFP	3
BFQ	6
BFR	8
BFT	10
BFU	12
BFV	16
BFW	20
BFX	25

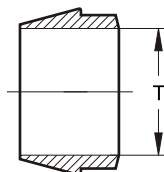

SINGLE FERRULE

Inch size tubing	
PART NO.	T'TUBE OD
SFA	1/8"
SFC	1/4"
SFE	5/16"
SFF	3/8"
SFG	1/2"
SFH	5/8"
SFJ	3/4"
SFK	7/8"
SFL	1"

Metric Size Tubing	
PART NO.	T'TUBE OD
SFP	3
SFQ	6
SFR	8
SFT	10
SFU	12
SFV	16
SFW	20
SFX	25

mmm.

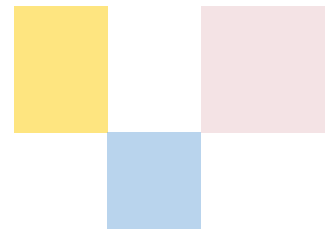

Chromatograph Fittings :

Tube fittings in different sizes (1/16", 1/8) are available for gas and liquid chromatography. They are made in different material and configuration.

Bored-Through Fittings :

Bored through fittings are used for connecting thermocouples or dip tubes. These connectors are available in SS, Brass, Monel, Hastalloy, Titanium etc. The root diameter of the pipe thread end of male connectors makes it impractical to bore through all size so female connectors, for instance 1/2" Tube x 1/4" NPT or 3/8" Tubex 1/4" NPT can not bore through. Please add suffix BT to order bore

Heat Exchanger Tee :

Available both in two piece (Union Tee and Bore through Reducer) and Single piece (Reducing Tee) design.

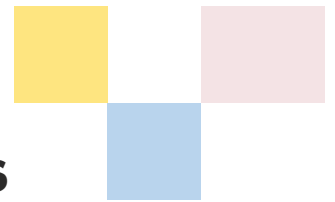

CHECK VALVES



- Check valves are available in Stainless Steel and Brass material
- Variety of end connections :- Male & Female NPT, BSPP, BSPT, ISO tapered pipe ends & SPRAYTECH tube fittings
- Maximum working pressure upto 6,000 psig (400 barg)
- Cracking pressure includes :- 1/3, 1, 5, 10, 25, 50, 75 & 100 psig
- All valves 100% factory tested
- Heat code traceability





NEEDLE VALVES



- Needle valves are available in IB, HB, HP, SB & Mini Series
- Available in SS 316, Brass, CS, Monel & Hastalloy materials in forged & bar stock construction
- Variety of end connections :- Male & Female NPT, BSPP, BSPT, ISO tapered pipe ends & SPRAYTECH tube fittings
- Maximum working pressure upto 20,000 psing (1406 Barg)
- PTFE Standard gland packing, Alternative graphoil packing for high temperature Max. temperature upto 538°C (1000°F)
- Non-rotating vee tip provided repetitive leak tight shut-off
- Packing below threads to prevent lubricant washout
- All valves 100% factory tested as per MSS-SP-99
- Heat code traceability



2, 3, 5, VALVE MANIFOLDS



- Manifolds are available in SS 316, CS, Monel & Hastalloys materials
- Various configuration - Pipe to Pipe, Pipe to Flange, Flange to Flange, Remote Mount and Direct Mount
- Non-Rotating vee tip provided repetitive leak tight shut-off.
- Maximum working pressure upto 10,000 psing (689 Barg)
- PTFE Standard glass packing, Alternative graphoil packing for high temperature Max. temperature upto 538°C (1000°F)
- Packing below threads to prevent lubricant washout
- Extremely adjustable gland
- Low operative torque
- All valves 100% factory tested as per MSS-SP-99



THERMOWELLS



'SPRAYTECH' offers a full range of custom made thermowell, designed to protect the temperature gauges from various corrosive media, pressure, and abrasives. They are designed to permit quick removal and easy fitment of thermometer for replacement, repair and testing.

FEATURES: Shank: Straight, Taper, Stepped. Mounting Style: Threaded, Socket weld, Flanged. Material of Construction: SS family, MS, Brass, Monel etc. Application: widely used for Bi-metal, Mercury, Gas filled thermometers sensors in various industries like paper and pulp, Food and beverage, chemicals, Petrochemicals, fertilizers and Power.

Straight Shank, threaded with or w/o Lag
Connection 1/2", 3/4", 1", Bore size: 0.385"

Stepped Shank, threaded with or w/o Lag
Connection 1/2", 3/4", 1", Bore size: 0.260"

Taper Shank, threaded with or w/o Lag
Connection 1/2", 3/4", 1", Bore size: 0.260", 0.385"

Weld-in Shank
Connection 1-1/2", Bore size: 0.260", 0.385"

Socket weld Shank, with or w/o Lag
Connection 1/2", 3/4", 1", Bore size: 0.260", 0.385"

Flanged End connection

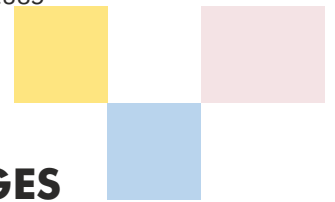

FLANGES



- ASME Code flanges
- Non Standard Non code flanges
- Weld neck, Slip On, Blind, stub End, Threaded, Socket Weld, SAE, Ring Type flanges
- Custom type flanges
- Available in Carbon Steel, Austenitic Steel, Alloy & Chrome steel etc.
- For pressure class 75, 125, 150, 300, 350, 400, 600, 900, 1500, 2500, 5K, 10K, 15K, 20K psi
- Sizes available in range of 1/2" to 203"



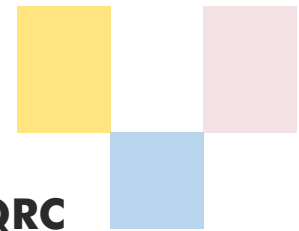

QRC (QUICK RELEASE COUPLING - PUSH & PULL TYPE)

We use latest technology and comprehensive quality control systems in designing and manufacturing wide range of Quick Release Coupling. Designed for reliable performance, our entire range is fabricated from qualitative raw material for ultimate durability and strength. These corrosion resistant coupling come with single & double shut off valves for avoiding leakage.

Working Principle

QRC type coupling work on Push and Pull principle. When the Adaptor is pushed to the coupler, its is accurately held by the self locking arrangement resulting in a positive & leak proof connection. This action simultaneously opens the valve & fluid flow starts. To disconnect, pull back the sleeve of the coupler, the Adaptor ejects out and the valves shut off automatically. Valves are provided in type one way sealing & two way sealing.



Features

Quick connect / Release Couplings eliminate valves and screw on fittings in many pneumatic, hydraulic and chemical systems.

Permits easy, safe, quick & reliable connections between delivery lines, pressure hoses etc.

Connection disconnection of fluid systems is as easy as



PRESSURE GAUGE ACCESSORIES

Syphon (Pig type, Ring type, U type) Gauge cock (2 way, 3 way), Snubber (Dampener), Gauge saver, Bleeder plug, Pressure gauge adaptors and reducers are available in SS 316/304.

Gauge saver



Bleeder Plug



Gauge cock



Snubber



Hose Nipple



Siphon



FORGED BRANCHOLET FITTINGS

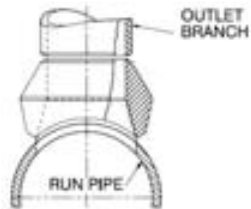

Brancholet butt welding outlet

Used to make full size and reducing size branch connections.

Wide bases at crotch section distribute internal and external stresses. Gradual changes of sections eliminate stress concentration. Funnel shaped opening provides improved flow conditions. Every fitting is shaped to fit the pipe and is self-aligning.

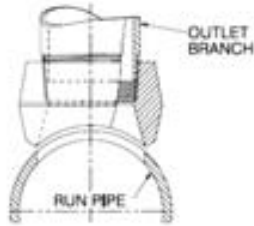

Brancholet Threaded outlet

Used for making threaded outlets to combine the economy and strength of welding with the flexibility of screwed construction.

Shaping and bevelling are unnecessary when threaded brancholets are used for branch connection no longer requires a large inventory of fittings.

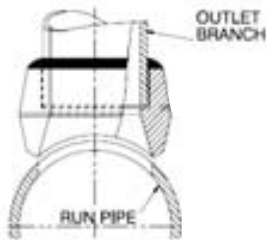

Brancholet socket welding outlet

Used for completely welded outlets where desirable for ease in lining up header branches. Use of brancholets precludes faulty fabrication like roughcut, branch pipe projection, notches present when the reinforcement is not completely integrated with the branch and run.



Nippolet

Nippolet provides a 1-piece forged fitting that eliminates a nipple, coupling and one-weld. It gives a sturdy branch connection for forged steel valves.

True angular relationship between outlets facilitate rapid, economical piping make up.



HIGH PRESSURE FORGED FITTINGS



Unions



45° Elbow



Tee



90° Elbow



Cross

Bored from solid drop forgings to provide the favourable metal qualities obtainable only from the forging process.

Smooth interior surfaces reduce turbulence and friction and minimize resistance to flow.

Wide reinforce bands provide extra strength at stress points.

Sharp clean threads accurately cut and carefully inspected to simplify piping make up.

Deep, true welding sockets are accurately bored to align inner surface with pipe and provide proper slip fit.

Standard range of products available in C.S. (Astm A105), stainless steel (ASTM A182), Alloy steel (A182), nace (Mr0175), Nickel alloys (ASTM B366). Dimensions are ANSI B16. 11, MSS Sp97 & BS 3799. Threading as per ANSI B1.20.1. other products include reducing outlet fittings, inserts, pipe nipples & elbowlets.



Bushing & plug

coupling

PLUGS AND BUSHINGS

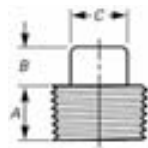

Square Head Plug

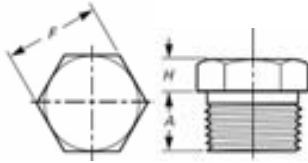

Hex Head Plug

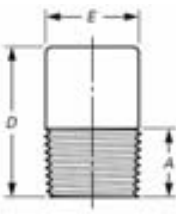

Round Head Plug

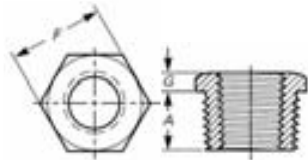

Hex Head Bushing (Note 1)

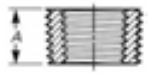

Flush Bushing

Plugs And Bushings

Nominal Pipe size	Length (Minimum) A	Plugs Square Head		Plugs Round Head		Hex Plugs & Bushings		
		Height of Square (Minimum) B	Width Flats (Minimum) C	Nominal Diameter of Head E	Length (Minimum) D	Width Flats (Nominal)	Hex Height (Min)	
							Bushing G	Plug H
6	10	6	7	10	35	11	0	6
8	11	6	10	13	41	16	3	6
10	13	8	11	16	41	18	4	8
15	14	10	14	21	44	22	5	8
20	16	11	16	27	44	27	6	10
25	19	13	21	33	51	36	6	10
32	21	14	24	43	51	46	7	14
40	21	16	28	48	51	50	8	16
50	22	18	32	60	64	65	9	18
65	27	19	36	73	70	75	10	19
80	28	21	41	80	70	90	10	21
100	32	25	65	114	76	115	13	25

Dimension are millimeters

THREADED FITTINGS

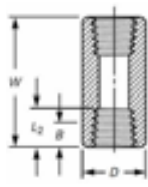

Coupling

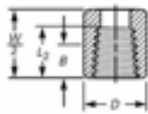

Half-Coupling

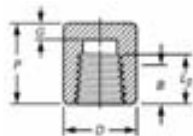

Cup

Threaded Fittings

Nominal Pipe size	End to End Couplings W		End to End Caps P		Outside Diameter D		End Eall Thickness G Min.		Length of Thread Min. (1)	
	3000 & 6000		3000	6000	3000	6000	3000	6000	B	L ₂
6	32		19		16	22	4.8		6.4	6.7
8	35		25	27	19	25	4.8	6.4	8.1	10.2
10	38		25	27	22	32	4.8	6.4	9.1	10.4
15	48		32	33	28	38	6.4	7.9	10.9	13.6
20	51		37	38	35	44	6.4	7.9	12.7	13.9
25	60		41	43	44	57	9.7	11.2	14.7	17.3
32	67		44	46	57	64	9.7	11.2	17.0	18.0
40	79		44	48	64	76	11.2	12.7	17.8	18.4
50	86		48	51	76	92	12.7	15.7	19.0	19.2
65	92		60	64	92	108	15.7	19.0	23.6	28.9
80	108		65	68	108	127	19.0	22.4	25.9	30.5
100	121		68	75	140	159	22.4	28.4	27.7	33.0

Dimension are millimeters

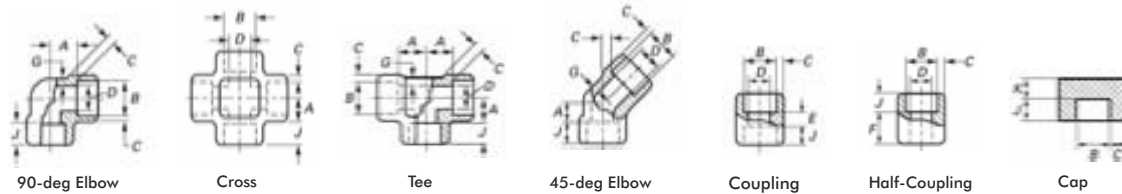

Socket - Welding Fittings																									
Norm Pipe Size	Socket Bore Dia (2)	Bore Diameter of Fitting (2)			Socket Wall Thickness C(1)						Body Wall Thickness G			Depth of Socket	Center To Bottom of Socket-A						Laying Lengths				
		D			Class Designation						Class Designation				90° Elbow Tees & Cross			45° Elbows			Halt				
		Class Designation			3000		6000		9000		3000				6000			9000			Class Designation			Class Designation	
	B	3000	6000	9000	Ave	Min	Ave	Min	Ave	Min	Min	Min	Min	Min-J	3000	6000	9000	3000	6000	9000	E	F			
6	11.2	7.6	4.8	0	3.18	3.18	3.96	3.43	0	0	2.41	3.15	0	9.5	12.0	12.0	0	9.0	9.0	0	8.0	12.0			
	10.8	6.1	3.2												10.0	10.0		7.0	7.0		5.0	15.0			
8	14.6	10.0	7.1		3.78	3.30	4.60	4.01			3.02	3.08		9.8	12.0	14.5		9.0	9.0		8.0	17.0			
	14.2	8.5	5.6												10.0	12.5		7.0	7.0		5.0	15.0			
10	18.0	13.3	9.9		4.01	3.50	5.03	4.37			3.20	4.01		9.5	15.0	17.0		9.5	12.5		9.5	19.0			
	17.6	11.8	8.4												12.0	14.0		6.5	9.5		3.5	16.0			
15	22.2	16.6	12.5	7.2	4.67	4.09	5.67	5.18	9.32	8.18	3.73	4.78	7.42	9.5	17.0	20.5	27.0	12.8	14.0	17	12.5	24.0			
	21.8	15.0	11.0	5.6											14.0	17.5	24.0	9.5	11.0	14	6.5	21.0			
20	27.0	21.7	16.3	11.8	4.90	4.27	6.96	6.04	9.78	8.56	3.01	5.56	7.82	12.5	20.5	24.0	30.0	14.5	15.5	20.5	12.5	25.5			
	27.2	20.2	14.8	10.3											17.5	21.0	27.0	11.5	12.6	17.5	6.5	22.5			
25	34.3	27.4	21.5	16.0	6.69	4.98	7.92	6.43	11.38	9.96	4.55	6.35	9.09	12.5	24.5	29.0	34.0	16.0	19.5	22.5	16.5	30.5			
	33.9	25.9	19.9	14.4											20.5	25.0	30.0	12.0	15.5	18.5	8.5	26.5			
30	43.1	35.8	30.2	23.5	6.07	5.28	7.92	6.93	12.14	10.62	4.85	6.35	9.70	12.5	29.0	34.0	37.0	19.5	22.5	24.5	16.5	32.0			
	42.5	34.3	28.7	22.0											25.0	30.0	33.0	15.5	18.5	20.6	8.5	28.0			
40	49.2	41.6	34.7	28.7	6.35	5.54	8.92	7.80	12.72	11.12	5.09	7.14	10.15	12.5	34.0	40.0	40.0	22.5	27.5	27.3	16.5	34.0			
	48.8	40.1	33.2	27.2											30.0	36.0	36.0	18.5	23.5	23.5	8.5	30.0			
50	61.2	53.6	43.6	38.9	6.93	6.04	10.92	9.50	13.84	12.12	5.54	8.74	11.07	16.0	40.0	43.0	56.0	27.5	30.5	30.5	23.0	43.0			
	61.2	51.7	42.1	37.4											36.0	39.0	52.0	23.5	26.5	26.5	15.0	39.0			
65	74.4	64.2			8.76	7.67					7.01			16.0	43.5			31.0			24.0	45.0			
	73.0	61.2													38.2			26.5			14.0	40.5			
80	90.3	79.4			9.52	8.30					7.62			16.0	59.5			34.5			24.0	47.0			
	89.8	76.4													54.5			29.5			14.0	42.0			
100	115.17	103.8			10.69	9.35					8.56			19.0	69.0			43.5			24.0	50.5			
	115.2	100.7													64.0			38.5			14.0	45.5			

Dimension are millimeters

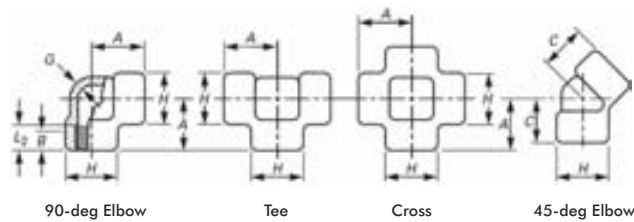

Forged Threaded Fittings														
Nominal Pipe	Center to End Elbos, Tees, Cross A			Centre to End 450 Elbow C			Outside Diameter of Band H			Minimum Wall Thickness G			Length of Thread Min.(1)	
	2000	3000	6000	2000	3000	6000	2000	3000	6000	2000	3000	6000	B	L ₂
6	21	21	25	17	17	19	22	22	25	3.18	2.41	6.35	6.4	6.7
10	21	25	28	17	19	22	22	25	33	3.18	3.30	6.60	8.1	10.2
10	25	28	33	19	22	25	25	33	38	3.18	3.51	6.98	9.1	10.4
15	28	33	38	22	25	28	33	38	46	3.18	4.09	8.15	10.9	13.6
20	33	38	44	25	28	33	38	46	56	3.18	4.32	8.53	12.7	13.9
25	38	44	51	28	33	35	46	56	62	3.68	4.98	9.93	14.7	17.3
32	44	51	60	33	35	43	56	62	75	3.89	5.28	10.59	17.0	18.0
40	51	60	64	35	43	44	62	75	84	4.01	5.56	11.07	17.8	18.4
50	60	64	83	43	44	52	75	84	102	4.27	7.14	12.09	19.0	19.2
65	76	83	95	52	52	64	92	102	121	5.61	7.65	15.29	23.6	28.9
80	86	95	106	64	64	79	109	121	146	5.99	8.84	16.64	25.9	30.5
100	106	114	114	79	79	79	145	152	162	6.55	11.18	18.67	27.7	33.0

Dimension are millimeters

ACCESSORIES



INSTRUMENT TUBING MATERIAL SELECTION GUIDE

Spraytech's instrument tube fittings have been designed to work in different application and environments, until & unless the material of tubing is selected properly for respective application the life of the system will remain in worry.

General Selection

The fluid media contained to flow inside the tubes and is compatibility with tube material play a main role.

Stainless steel fittings should be used only with stainless steel tubing, Aluminum fittings with aluminium tubes etc. mixing of different materials is to be prohibited. The only exception is brass fittings with copper tubing.

Gas Service

Special care must be taken during selection of tubes for pressurised gas services. In order to achieve leak proof sealing between ferrule and tube the tube material must be softer than ferrule so it will penetrate in to tube.

Tube material	General Application	Recommended Temp. Range
Ss316	High Pressure, High Temperature, Corrosive media	-250°C to 600°C
Carbon Steel	High Pressure, High Temperature oil, Air, Inert Chemicals	-29°C to 425°C
Copper	Low temperature, Low pressure water, Oil, Air, Gas	-40°C to 200°C
Aluminum	Low temperature, Low pressure water, Oil, Air, Gas	-40°C to 200°C
Monel 400	Sour Gas application, Marine Chemical application	-195°C to 420°C
Hastelloy C-276	Excellent corrosion resistance to both oxidizing and reducing media and localized corrosion attack	-195°C to 520°C
Inconel 600	High temperature application with corrosive media	-145°C to 620°C
Titanium	Sea water, salt solutions, acidic media	-59°C to 316°C

System Pressure

The system pressure is another mechanical parameter for selection of material off tubes. In general, high pressure installations require strong materials such as steel or stainless steel. Copper may be used if chemical compatibility exists with the media. The higher strength of steel or stainless steel permits the use of thinner tubes without reducing the ultimate rating of the system.

CONVERSION DATA

MULTIPLY	By	TO OBTAIN
Feet/sec	18.29	Meters/Min
Feet or Water	0.0295	Atmospheres
Feet or Water	0.884	Inches of Mercury
Feet or Water	0.433	Psi
Gallons	3785	Cm ³
Gallons	0.1337	Ft ³
Gallons	0.83257	Imperial Gallons
Gallons	3.785	Liters
Gallons/min	0.06308	Liters/sec
Imperial Gallons	1.2	Gallons
Horsepower	1.014	Horsepower (metric)
Horsepower	33.000	Foot pounds/min
Horsepower	746	Watts
Inches	2.54	Centimeters
Kg/cm ²	14.22	Psi
Kilo Watts	1.340	Horsepower
Liters	1000	Cm ³
Liters	0.264	Gallons
Liters	0.22	Imperial Gallons
Liters	33.8	Ounces (Fluid)
Meters	3.281	Feet
Microns (μ)	0.0394	Thousandth of an inch
Miles/hr	44.7	Centimeters/sec
Miles/hr	1.467	Feet/sec
Millimeres	0.0394	Inches
Psi	0.068	Atmospheres
Psi	0.06895	Bar
Psi	2.307	Feet of Water
Psi	0.0703	Kg/cm ²
Psi	6.895	KPA

MULTIPLY	By	TO OBTAIN
Atmospheres	1.013	Bar
Atmospheres	33.931	Feet of water
Atmospheres	1.0332	Kg/cm ³
Atmospheres	101.3Kilo	Pascals (k Pa)
Atmospheres	14.696	Psi
Bar	100	KPA
Bar	14.5	Psi
Barrels (oil)	42	Galions
Centimeters	0.3937	Inches
Centi Stokes	Sp.gravity	Centi Poise
Cm ³	0.061	in ³
Cm ³	0.000264	Gallons
Cm ³	0.001	Liters
Ft ³	1728	in ³
Ft ³	0.02832	M ³
Ft ³	7.48	Gallons
Ft ³	28.32	Liters
Ft ³ (water)	62.43	Pounds (Water)
In ³	16.39	Cm ²
In ³	0.00433	Gallons
In ³	0.164	Liters
M ³	35.31	Ft ³
M ³	61.016	In ³
M ³	264.2	Gallons
M ³	1000	Liters
Degree (Angle)	60	Minutes
Degree (Celsius)	(°C x 1.8)+32	Degree (Fahrenheit)
Degree (Fahrenheit)	(°F - 32)x0.56	Degree (Celsius)
Feet	0.3048	Meters
Feet/sec	30.48	Centimeters/sec

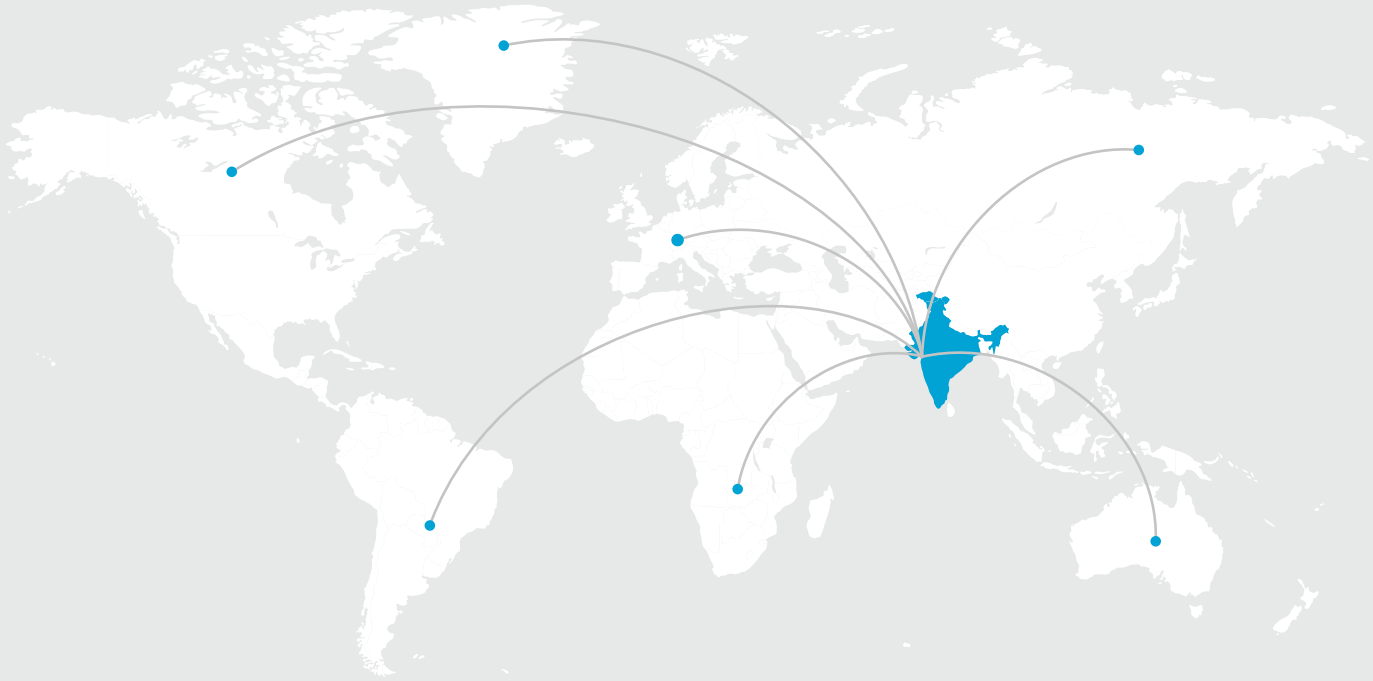

OUR BRANCHES

Regd. Office (Mumbai) :

Spraytech House, Plot A-132, Road No. 23, Spraytech Circle,
Wagle Indl. Estate, Thane (W) - 400 604. Mumbai Maharashtra, (India)
Tel. : 91-022-2582 8929 / 2735 / 2736
E-mail :- sales@spraytechindia.com
sales1@spraytechindia.com

Rabale Plant 1 (Navi Mumbai) :

Spraytech Systems (I) Pvt. Ltd., Plot No.: R-513, MIDC, TTC Industrial
Area, Rabale, Navi Mumbai - 400 701.

Rabale Plant 2 (Navi Mumbai) :

R-446, T.T.C. Industrial Area, MIDC Rabale,
Navi Mumbai - 400 701.

Branch Office (Pune) :

White House, Survey no. 161, Near
Bhosale Garden Hadapsar, Pune 411028

Indapur Plant (Pune) :

Spraytech Systems (I) Pvt. Ltd., Plot No.: A-5, Indapur Five Star
Industrial Area, Village - Loni Devkar Balpudi, Tal. - Indapur,
Dist. - Pune. - 413132